

New "Global Standard" Endmill Series

GSX



New "Global Standard" Solid Endmill GSX MILL Series



■ Characteristics and Applications

- Wide variation of three flute types and four flute lengths enable use in a wide variety of applications.
- Fine carbide substrate provides high toughness and excellent thermal shock resistance improving reliability in wet cutting applications.
- GSX Coating provides improved reliability and longer tool life.
- Large rake angle and unique flute design improve sharpness and chip evacuation.
- Cutting teeth with gash land improve corner flute strength.
- Sharper edge S type and fracture resistant C type added to the 2D size series.

■ Wear Resistance

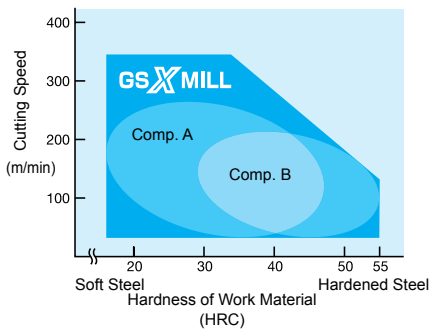

■ Thermal Resistance

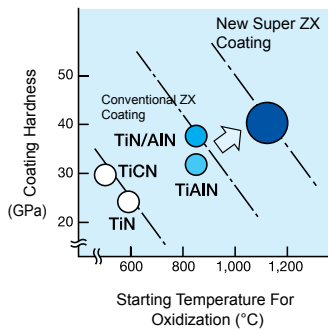

■ Improved Chip Evacuation

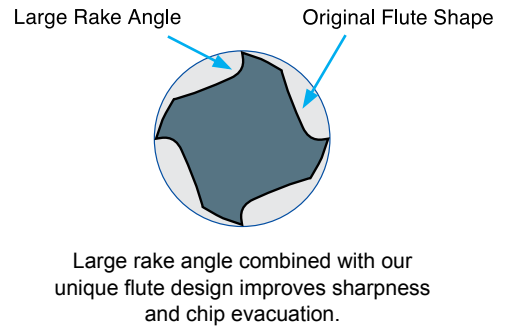

■ Two cutting edge designs expand machining applications

Sharper edge S type added to the 2D + 4D size series.

S Type

Sharp Corner: Sharper Edge Design

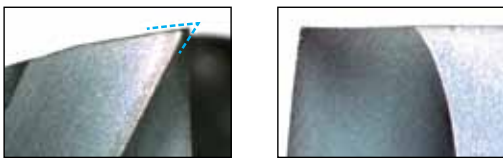

Note:
With gash land, some material remains as shown on the right. If you need sharp corners, use the S Type.

Ex.: Corner on a ϕ 10 mm hole

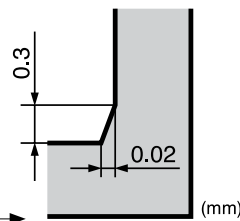

■ Multi-Purpose

Optimized flute design of slotted 3 flute (short) type reduces cutting resistance.

1. Allows drilling and slot milling and other continuous (compound) applications.
2. Perfect for use with thin sheets and small machining centres.



C Type

Gash Land: Fracture Resistant Design



■ Application Range











P					H			M	S	K	N			
General Structure Rolled Steel	Carbon Steel	Alloy Steel	Pre-hardened Steel	Die Steel	Hardened Steel			Stainless Steel	Ti Alloy	Heat Resistant Alloy	Cast Iron	Al Alloy	Copper Alloy	Graphite
					45 to 55 HRC	55 to 60 HRC	60 HRC							
○	○	○	○	○	⊙ ^{*1}			○	○	○				

*1 : GSXSLT30000C is recommended for 50 HRC or less.

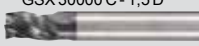
■ Recommended Milling Examples

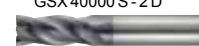
Application	Shoulder Milling		Grooving		Groove Finishing	
Form						
	Rough	Finishing	Rough	Finishing	Rough	Finishing
S Type		○		○ ^{*2}		○
C Type	○	○	○	○	○	○
S Type is best for removing inside corners					*2: Use with small depth of cut.	

■ Product Range

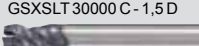
Application	No. of Teeth	Flute Length				
		1,5D	2D	3D	4D	
General Purpose	2	GSX 20000 C - 1,5D 	GSX 20000 S - 2D 	GSX 20000 C - 2D 	GSX 20000 C - 3D 	GSX 20000 C - 4D 
	3	GSX 30000 C - 1,5D 		GSX 30000 C - 2D 		
	4	GSX 40000 C - 1,5D 	GSX 40000 S - 2D 	GSX 40000 C - 2D 	GSX 40000 C - 3D 	GSX 40000 C - 4D 
Compound Endmilling	3	GSXSLT 30000 C - 1,5D 				

■ GSX MILL BALL

Series	No. of Teeth	Shape	Diameter (mm)
GSXB 20000	2		R0,2 to R 15 (ø 0,4 to ø 30)



■ Application Range

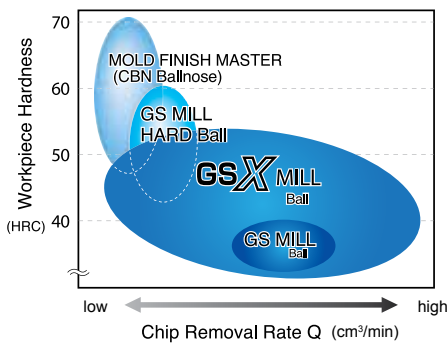



■ Characteristics and Applications

- Large helix angle on cutting edge reduces cutting resistance.
- Unique pocket design and expanded pocket area promotes better chip evacuation.

Expands the range of machineable material from soft to hardened steels, and offers reliability and longer tool life.

■ GSX MILL Anti-Vibration Type (Square / Radius)

Series	No. of Teeth	Shape	Diameter (mm)
GSXVL 4000-2,5D	4 R		ø 2 to ø 20
Series	No. of Teeth	Shape	Diameter (mm)
GSXVL 4000R-2,5D	4 R		ø 3 to ø 20



■ Cutting Range

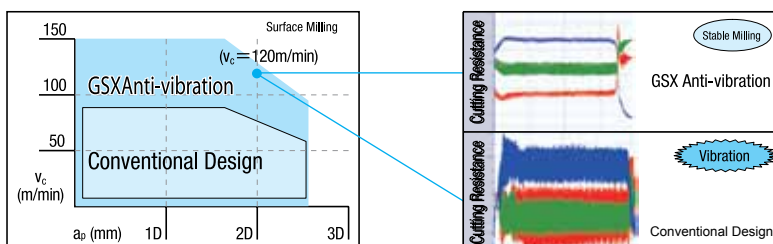

GSX MILL Anti-Vibration Type (Square/Radius)

■ Characteristics and Applications

- Optimized irregular pitch and lead affords:
 - drastically improved chattering and fracture resistance
 - less cutting force -> allows high-speed, high-feed cutting
- Rounded lands greatly improve machined surface quality (from ø 4)

GSX ENDMILL

GSX 2000C-1,5 D

Endmill Identification (GSXMILL Series Only)

GSX 2 0100 C - 1,5 D

Series Code	No. of Teeth	Diameter	Cutting Edge	Cutting Edge Length
General Steel	4	1,0 to 20,0	Standard	100
Carbon Steel	4	1,0 to 20,0	Standard	100
Alloy Steel	4	1,0 to 20,0	Standard	100
Pre-hardened Steel	4	1,0 to 20,0	Standard	100
Tempered Steel (Die Steel)	4	1,0 to 20,0	Standard	100
Hardened Steel	4	1,0 to 20,0	Standard	100
Stainless Steel	4	1,0 to 20,0	Standard	100
Ti Alloy (Heat Resistant Alloy)	4	1,0 to 20,0	Standard	100
Cast Iron	4	1,0 to 20,0	Standard	100
Al Alloy	4	1,0 to 20,0	Standard	100
Copper Alloy	4	1,0 to 20,0	Standard	100
Graphite	4	1,0 to 20,0	Standard	100

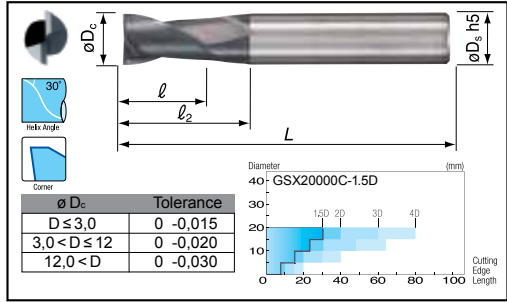

Body

(mm)

Cat. No.	Stock	ϕD_c	l_1	l_2	L	ϕD_s
GSX 20100C-1,5 D	•	1,0	1,5	2,5	40	4
GSX 20150C-1,5 D	•	1,5	2,3	3,3	40	4
GSX 20200C-1,5 D	•	2,0	3,0	4,0	40	4
GSX 20250C-1,5 D	•	2,5	3,8	4,8	40	4
GSX 20300C-1,5 D	•	3,0	4,5	6,0	45	6
GSX 20350C-1,5 D	•	3,5	5,3	6,8	45	6
GSX 20400C-1,5 D	•	4,0	6,0	7,5	45	6
GSX 20450C-1,5 D	•	4,5	6,8	8,3	50	6
GSX 20500C-1,5 D	•	5,0	7,5	9,5	50	6
GSX 20550C-1,5 D	•	5,5	8,3	10,3	50	6
GSX 20600C-1,5 D	•	6,0	9,0	-	50	6
GSX 20700C-1,5 D	•	7,0	11,0	13,0	60	8
GSX 20800C-1,5 D	•	8,0	12,0	-	60	8
GSX 20900C-1,5 D	•	9,0	14,0	16,0	70	10
GSX 21000C-1,5 D	•	10,0	15,0	-	70	10
GSX 21200C-1,5 D	•	12,0	18,0	-	75	12
GSX 21400C-1,5 D	•	14,0	21,0	24,5	90	16
GSX 21500C-1,5 D	•	15,0	23,0	26,5	90	16
GSX 21600C-1,5 D	•	16,0	24,0	-	90	16
GSX 22200C-1,5 D	•	20,0	30,0	-	100	20

• Euro-Stock • Japan-Stock

Grade: ACF20

Recommended Cutting Conditions

- For stable machining performance use rigid, high-precision machines and holders.
- Use compressed air when dry machining.
- Use wet machining for stainless steel, heat resistant alloy, and titanium alloy applications.
- If chattering is a problem, reduce the Spindle Speed and feed rate indicated in the table below by the same ratio, or reduce the depth of cut.
- If the machine cannot achieve the recommended spindle speed, please use the max. spindle speed available.

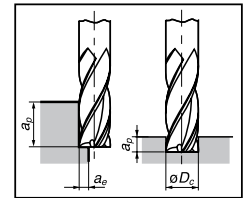

Shoulder Milling

Work Material	Structural Steel		Carbon Steel (150-250 HB)		Cast Iron		Alloy Steel (25-35 HRC)		Tempered Steel, Hardened Steel (35-45 HRC)		Hardened Steel (45-55 HRC)		Stainless Steel		Heat Resistant Steel Titanium Alloy	
	Spindle Speed (min ⁻¹)	Feed Rate (mm/min ⁻¹)	Spindle Speed (min ⁻¹)	Feed Rate (mm/min ⁻¹)	Spindle Speed (min ⁻¹)	Feed Rate (mm/min ⁻¹)	Spindle Speed (min ⁻¹)	Feed Rate (mm/min ⁻¹)	Spindle Speed (min ⁻¹)	Feed Rate (mm/min ⁻¹)	Spindle Speed (min ⁻¹)	Feed Rate (mm/min ⁻¹)	Spindle Speed (min ⁻¹)	Feed Rate (mm/min ⁻¹)	Spindle Speed (min ⁻¹)	Feed Rate (mm/min ⁻¹)
Dc (mm)																
1,0	19,600	250	19,600	250	19,600	250	18,300	180	12,700	100	9,000	60	11,000	70	9,000	50
2,0	11,200	340	11,200	340	11,200	340	10,500	240	7,300	130	5,300	80	6,400	90	5,300	70
4,0	6,400	460	6,400	460	6,400	460	6,000	320	4,200	180	3,000	110	3,600	120	3,000	90
6,0	4,600	560	4,600	560	4,600	560	4,300	400	3,000	210	2,200	130	2,700	140	2,200	100
8,0	3,400	560	3,400	560	3,400	560	3,200	400	2,200	210	1,600	130	2,000	140	1,600	100
10,0	2,800	560	2,800	560	2,800	560	2,600	400	1,800	210	1,300	130	1,600	140	1,300	100
12,0	2,300	560	2,300	560	2,300	560	2,200	400	1,500	210	1,100	130	1,300	140	1,100	100
16,0	1,700	450	1,700	450	1,700	450	1,600	320	1,100	180	800	100	1,000	110	800	85
20,0	1,350	380	1,350	380	1,350	380	1,300	280	900	160	650	90	800	100	650	75
Standard Depth of cut	ae						1,5 Dc						1,0 Dc			
	ae						0,05 Dc						0,02 Dc			

Grooving

Work Material	Structural Steel		Carbon Steel (150-250 HB)		Cast Iron		Alloy Steel (25-35 HRC)		Tempered Steel, Hardened Steel (35-45 HRC)		Hardened Steel (45-55 HRC)		Stainless Steel		Heat Resistant Steel Titanium Alloy	
	Spindle Speed (min ⁻¹)	Feed Rate (mm/min ⁻¹)	Spindle Speed (min ⁻¹)	Feed Rate (mm/min ⁻¹)	Spindle Speed (min ⁻¹)	Feed Rate (mm/min ⁻¹)	Spindle Speed (min ⁻¹)	Feed Rate (mm/min ⁻¹)	Spindle Speed (min ⁻¹)	Feed Rate (mm/min ⁻¹)	Spindle Speed (min ⁻¹)	Feed Rate (mm/min ⁻¹)	Spindle Speed (min ⁻¹)	Feed Rate (mm/min ⁻¹)	Spindle Speed (min ⁻¹)	Feed Rate (mm/min ⁻¹)
Dc (mm)																
1,0	19,600	200	19,600	250	19,600	250	18,300	180	12,700	100	9,000	60	11,000	50	4,500	20
2,0	11,200	270	11,200	340	11,200	340	10,500	240	7,300	130	5,300	80	6,400	65	2,650	25
4,0	6,400	370	6,400	460	6,400	460	6,000	320	4,200	180	3,000	110	3,600	80	1,500	35
6,0	4,600	450	4,600	560	4,600	560	4,300	400	3,000	210	2,200	130	2,700	100	1,000	40
8,0	3,400	450	3,400	560	3,400	560	3,200	400	2,200	210	1,600	130	2,000	100	800	40
10,0	2,800	450	2,800	560	2,800	560	2,600	400	1,800	210	1,300	130	1,600	100	650	40
12,0	2,300	450	2,300	560	2,300	560	2,200	400	1,500	210	1,100	130	1,300	100	500	40
16,0	1,700	360	1,700	450	1,700	450	1,600	320	1,100	180	800	100	1,000	80	400	35
20,0	1,350	300	1,350	380	1,350	380	1,300	280	900	160	650	90	800	70	320	30
Standard Depth of cut	ae						0,5 Dc				0,2 Dc		0,05 Dc			
	ae	0,2 Dc													0,2 Dc	

Endmill Identification

GSX 2 0050 S - 2 D

Series Code No. of Teeth Diameter Cutting Edge Cutting Edge Length

General Steel	Carbon Steel	Alloy Steel	Pre-hardened Steel	Tempered Steel	Die Steel	Hardened Steel	Stainless Steel	Ti Alloy	Heat Resistant Alloy	Cast Iron	Al Alloy	Copper Alloy	Graphite
•	•	•	•	•	•	45 to 55 HRC	55 to 60 HRC	60 to 65 HRC	•	•	•	•	•

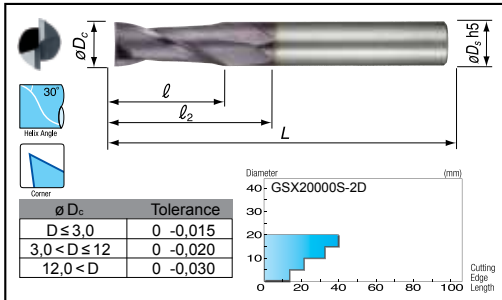

Body

(mm)

Cat. No.	Stock	ϕD_c	l_1	l_2	L	ϕD_s
GSX 20050S-2D	•	0,5	1,3	1,7	40	4
GSX 20100S-2D	•	1,0	2,5	3,5	40	4
GSX 20150S-2D	•	1,5	3,8	4,8	40	4
GSX 20200S-2D	•	2,0	5,0	6,0	40	4
GSX 20250S-2D	•	2,5	6,3	7,3	40	4
GSX 20300S-2D	•	3,0	7,5	9,0	45	6
GSX 20350S-2D	•	3,5	8,8	10,3	45	6
GSX 20400S-2D	•	4,0	11,0	14,0	45	6
GSX 20450S-2D	•	4,5	11,3	12,8	50	6
GSX 20500S-2D	•	5,0	13,0	19,6	50	6
GSX 20550S-2D	•	5,5	13,0	19,6	50	6
GSX 20600S-2D	•	6,0	13,0	—	50	6
GSX 20700S-2D	•	7,0	16,0	21,1	60	8
GSX 20800S-2D	•	8,0	19,0	—	60	8
GSX 20900S-2D	•	9,0	19,0	24,1	70	10
GSX 21000S-2D	•	10,0	22,0	—	70	10
GSX 21200S-2D	•	12,0	26,0	—	75	12
GSX 21600S-2D	•	16,0	32,0	—	90	16
GSX 22000S-2D	•	20,0	40,0	—	100	20

• Euro-Stock ◦ Japan-Stock

Grade: ACF20

Recommended Cutting Conditions

1. For stable machining performance use rigid, high-precision machines and holders.
2. Use compressed air when dry machining.
3. Use wet machining for stainless steel, heat resistant alloy, and titanium alloy applications.
4. If chattering is a problem, reduce the Spindle Speed and feed rate indicated in the table below by the same ratio, or reduce the depth of cut.
5. If the machine cannot achieve the recommended spindle speed, please use the max. spindle speed available.

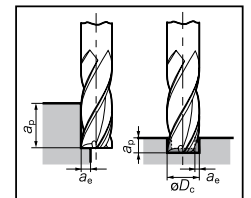

Shoulder Milling

Work Material	Structural Steel		Carbon Steel (150 - 250 HB)		Cast Iron		Alloy Steel (25 - 35 HRC)		Tempered Steel, Hardened Steel (35 - 45 HRC)		Hardened Steel (45 - 55 HRC)		Stainless Steel		Heat Resistant Steel Titanium Alloy	
	Spindle Speed (min ⁻¹)	Feed Rate (mm/min ⁻¹)	Spindle Speed (min ⁻¹)	Feed Rate (mm/min ⁻¹)	Spindle Speed (min ⁻¹)	Feed Rate (mm/min ⁻¹)	Spindle Speed (min ⁻¹)	Feed Rate (mm/min ⁻¹)	Spindle Speed (min ⁻¹)	Feed Rate (mm/min ⁻¹)	Spindle Speed (min ⁻¹)	Feed Rate (mm/min ⁻¹)	Spindle Speed (min ⁻¹)	Feed Rate (mm/min ⁻¹)	Spindle Speed (min ⁻¹)	Feed Rate (mm/min ⁻¹)
D_c (mm)																
1,0	16,600	180	16,600	180	16,600	180	15,500	130	10,500	70	7,500	45	9,400	50	7,500	35
2,0	9,500	250	9,500	250	9,500	250	9,000	200	6,200	100	4,500	60	5,400	70	4,500	50
4,0	5,400	330	5,400	330	5,400	330	5,000	250	3,400	120	2,500	75	3,000	90	2,500	65
6,0	4,000	400	4,000	400	4,000	400	3,700	300	2,550	150	1,900	100	2,300	110	1,900	80
8,0	3,000	400	3,000	400	3,000	400	2,800	300	1,900	150	1,400	100	1,700	110	1,400	80
10,0	2,400	400	2,400	400	2,400	400	2,200	300	1,500	150	1,100	100	1,300	110	1,100	80
12,0	2,000	400	2,000	400	2,000	400	1,850	300	1,300	150	950	100	1,100	110	950	80
16,0	1,500	330	1,500	330	1,500	330	1,400	250	950	120	700	75	850	85	700	60
20,0	1,200	280	1,200	280	1,200	280	1,100	220	750	110	550	65	650	75	550	55
Standard Depth of cut	a_p	a_e	0,02 D_c				2,0 D_c				0,01 D_c					

Grooving

Work Material	Structural Steel		Carbon Steel (150 - 250 HB)		Cast Iron		Alloy Steel (25 - 35 HRC)		Tempered Steel, Hardened Steel (35 - 45 HRC)		Hardened Steel (45 - 55 HRC)		Stainless Steel		Heat Resistant Steel Titanium Alloy	
	Spindle Speed (min ⁻¹)	Feed Rate (mm/min ⁻¹)	Spindle Speed (min ⁻¹)	Feed Rate (mm/min ⁻¹)	Spindle Speed (min ⁻¹)	Feed Rate (mm/min ⁻¹)	Spindle Speed (min ⁻¹)	Feed Rate (mm/min ⁻¹)	Spindle Speed (min ⁻¹)	Feed Rate (mm/min ⁻¹)	Spindle Speed (min ⁻¹)	Feed Rate (mm/min ⁻¹)	Spindle Speed (min ⁻¹)	Feed Rate (mm/min ⁻¹)	Spindle Speed (min ⁻¹)	Feed Rate (mm/min ⁻¹)
D_c (mm)																
1,0	16,600	180	16,600	180	16,600	180	15,500	130	10,500	70	7,500	45	9,400	50	7,500	35
2,0	9,500	250	9,500	250	9,500	250	9,000	200	6,200	100	4,500	60	5,400	70	4,500	50
4,0	5,400	330	5,400	330	5,400	330	5,000	250	3,400	120	2,500	75	3,000	90	2,500	65
6,0	4,000	400	4,000	400	4,000	400	3,700	300	2,550	150	1,900	100	2,300	110	1,900	80
8,0	3,000	400	3,000	400	3,000	400	2,800	300	1,900	150	1,400	100	1,700	110	1,400	80
10,0	2,400	400	2,400	400	2,400	400	2,200	300	1,500	150	1,100	100	1,300	110	1,100	80
12,0	2,000	400	2,000	400	2,000	400	1,850	300	1,300	150	950	100	1,100	110	950	80
16,0	1,500	330	1,500	330	1,500	330	1,400	250	950	120	700	75	850	85	700	60
20,0	1,200	280	1,200	280	1,200	280	1,100	220	750	110	550	65	650	75	550	55
Standard Depth of cut	a_p	a_e	1,5 D_c				0,02 D_c									

GSX ENDMILL

GSX 2000C -2 D

Endmill Identification (GSXMILL Series Only)

GSX 2 0050 C - 2 D

Series Code	No. of Teeth	Diameter	Cutting Edge	Cutting Edge Length
General Steel	4	50	2	20
Carbon Steel	4	50	2	20
Alloy Steel	4	50	2	20
Pre-hardened Steel	4	50	2	20
Tempered Steel	4	50	2	20
Hardened Steel	4	50	2	20
Stainless Steel	4	50	2	20
Ti Alloy	4	50	2	20
Cast Iron	4	50	2	20
Al Alloy	4	50	2	20
Copper Alloy	4	50	2	20
Graphite	4	50	2	20

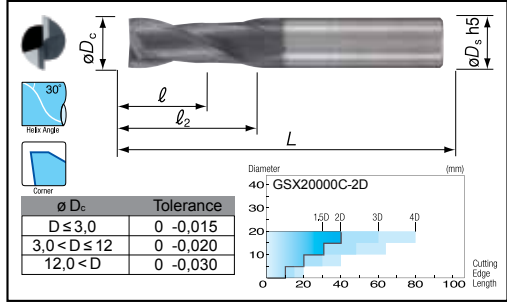

Body

(mm)

Cat. No.	Stock	ϕD_c	l_1	l_2	L	ϕD_s
GSX 20050C-2D	•	0,5	1,0	1,4	40	4
GSX 20100C-2D	•	1,0	2,0	3,0	40	4
GSX 20150C-2D	•	1,5	3,0	4,0	40	4
GSX 20200C-2D	•	2,0	4,0	5,0	40	4
GSX 20250C-2D	•	2,5	5,0	6,0	40	4
GSX 20300C-2D	•	3,0	6,0	7,5	45	6
GSX 20350C-2D	•	3,5	7,0	8,5	45	6
GSX 20400C-2D	•	4,0	8,0	9,3	45	6
GSX 20450C-2D	•	4,5	9,0	10,5	50	6
GSX 20500C-2D	•	5,0	10,0	12,0	50	6
GSX 20550C-2D	•	5,5	11,0	13,0	50	6
GSX 20600C-2D	•	6,0	12,0	—	50	6
GSX 20700C-2D	•	7,0	14,0	16,0	60	8
GSX 20800C-2D	•	8,0	16,0	—	60	8
GSX 20900C-2D	•	9,0	18,0	20,0	70	10
GSX 21000C-2D	•	10,0	20,0	—	70	10
GSX 21200C-2D	•	12,0	24,0	—	75	12
GSX 21400C-2D	•	14,0	28,0	31,5	90	16
GSX 21500C-2D	•	15,0	30,0	33,5	90	16
GSX 21600C-2D	•	16,0	32,0	—	90	16
GSX 22000C-2D	•	20,0	34,0	—	100	20

• Euro-Stock • Japan-Stock

Grade: ACF20

Recommended Cutting Conditions

- For stable machining performance use rigid, high-precision machines and holders.
- Use compressed air when dry machining.
- Use wet machining for stainless steel, heat resistant alloy, and titanium alloy applications.
- If chattering is a problem, reduce the Spindle Speed and feed rate indicated in the table below by the same ratio, or reduce the depth of cut.
- If the machine cannot achieve the recommended spindle speed, please use the max. spindle speed available.

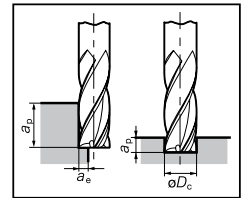

Shoulder Milling

Work Material	Structural Steel SS		Carbon Steel SC (150-250 HB)		Cast Iron FC		Alloy Steel SCM (25-35 HRC)		Tempered Steel, Hardened Steel NAK, HPM (35-45 HRC)		Hardened Steel (45-55 HRC)		Stainless Steel SUS304, SUS316		Heat Resistant Steel Titanium Alloy	
	Spindle Speed (min ⁻¹)	Feed Rate (mm/min ⁻¹)	Spindle Speed (min ⁻¹)	Feed Rate (mm/min ⁻¹)	Spindle Speed (min ⁻¹)	Feed Rate (mm/min ⁻¹)	Spindle Speed (min ⁻¹)	Feed Rate (mm/min ⁻¹)	Spindle Speed (min ⁻¹)	Feed Rate (mm/min ⁻¹)	Spindle Speed (min ⁻¹)	Feed Rate (mm/min ⁻¹)	Spindle Speed (min ⁻¹)	Feed Rate (mm/min ⁻¹)	Spindle Speed (min ⁻¹)	Feed Rate (mm/min ⁻¹)
D _c (mm)																
1,0	19,600	250	19,600	250	19,600	250	18,300	180	12,700	100	9,000	60	11,000	70	9,000	50
2,0	11,200	340	11,200	340	11,200	340	10,500	240	7,300	130	5,300	80	6,400	90	5,300	70
4,0	6,400	460	6,400	460	6,400	460	6,000	320	4,200	180	3,000	110	3,600	120	3,000	90
6,0	4,600	560	4,600	560	4,600	560	4,300	400	3,000	210	2,200	130	2,700	140	2,200	100
8,0	3,400	560	3,400	560	3,400	560	3,200	400	2,200	210	1,600	130	2,000	140	1,600	100
10,0	2,800	560	2,800	560	2,800	560	2,600	400	1,800	210	1,300	130	1,600	140	1,300	100
12,0	2,300	560	2,300	560	2,300	560	2,200	400	1,500	210	1,100	130	1,300	140	1,100	100
16,0	1,700	450	1,700	450	1,700	450	1,600	320	1,100	180	800	100	1,000	110	800	85
20,0	1,350	380	1,350	380	1,350	380	1,300	280	900	160	650	90	800	100	650	75
Standard Depth of cut	a _p				1,5 D _c								1,0 D _c			
	a _e				0,05 D _c								0,02 D _c			

Grooving

Work Material	Structural Steel SS		Carbon Steel SC (150-250 HB)		Cast Iron FC		Alloy Steel SCM (25-35 HRC)		Tempered Steel, Hardened Steel NAK, HPM (35-45 HRC)		Hardened Steel (45-55 HRC)		Stainless Steel SUS304, SUS316		Heat Resistant Steel Titanium Alloy	
	Spindle Speed (min ⁻¹)	Feed Rate (mm/min ⁻¹)	Spindle Speed (min ⁻¹)	Feed Rate (mm/min ⁻¹)	Spindle Speed (min ⁻¹)	Feed Rate (mm/min ⁻¹)	Spindle Speed (min ⁻¹)	Feed Rate (mm/min ⁻¹)	Spindle Speed (min ⁻¹)	Feed Rate (mm/min ⁻¹)	Spindle Speed (min ⁻¹)	Feed Rate (mm/min ⁻¹)	Spindle Speed (min ⁻¹)	Feed Rate (mm/min ⁻¹)	Spindle Speed (min ⁻¹)	Feed Rate (mm/min ⁻¹)
D _c (mm)																
1,0	19,600	200	19,600	250	19,600	250	18,300	180	12,700	100	9,000	60	11,000	50	4,500	20
2,0	11,200	270	11,200	340	11,200	340	10,500	240	7,300	130	5,300	80	6,400	65	2,650	25
4,0	6,400	370	6,400	460	6,400	460	6,000	320	4,200	180	3,000	110	3,600	80	1,500	35
6,0	4,600	450	4,600	560	4,600	560	4,300	400	3,000	210	2,200	130	2,700	100	1,000	40
8,0	3,400	450	3,400	560	3,400	560	3,200	400	2,200	210	1,600	130	2,000	100	800	40
10,0	2,800	450	2,800	560	2,800	560	2,600	400	1,800	210	1,300	130	1,600	100	650	40
12,0	2,300	450	2,300	560	2,300	560	2,200	400	1,500	210	1,100	130	1,300	100	500	40
16,0	1,700	360	1,700	450	1,700	450	1,600	320	1,100	180	800	100	1,000	80	400	35
20,0	1,350	300	1,350	380	1,350	380	1,300	280	900	160	650	90	800	70	320	30
Standard Depth of cut	a _p				0,2 D _c				0,2 D _c		0,05 D _c				0,2 D _c	
	a _e						0,5 D _c									

■ Endmill Identification (GSXMILL Series Only)

GSX 2 0100 C - 3 D

Series Code No. of Teeth Diameter Cutting Edge Cutting Edge Length

General Steel	Carbon Steel	Alloy Steel	Pre-hardened Steel	Tempered Steel	Die Steel	Hardened Steel	Stainless Steel	Ti Alloy	Heat Resistant Alloy	Cast Iron	Al Alloy	Copper Alloy	Graphite
•	•	•	•	•	•	45 to 55 HRC	55 to 60 HRC	60 to 65 HRC	•	•	•	•	•

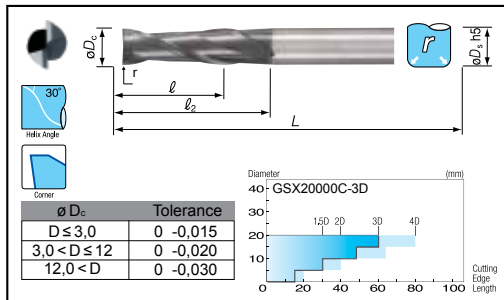

■ Body

(mm)

Cat. No.	Stock	∅ D _c	l ₁	l ₂	L	∅ D _s
GSX 20050C-3 D	•	0,5	1,3	1,7	40	4
GSX 20100C-3 D	•	1,0	2,5	3,5	40	4
GSX 20150C-3 D	•	1,5	3,8	4,8	40	4
GSX 20200C-3 D	•	2,0	5,0	6,0	40	4
GSX 20250C-3 D	•	2,5	6,3	7,3	40	4
GSX 20300C-3 D	•	3,0	7,5	9,0	45	6
GSX 20350C-3 D	•	3,5	8,8	10,3	45	6
GSX 20400C-3 D	•	4,0	11,0	14,0	45	6
GSX 20450C-3 D	•	4,5	11,3	12,8	50	6
GSX 20500C-3 D	•	5,0	13,0	19,6	50	6
GSX 20550C-3 D	•	5,5	13,0	19,6	50	6
GSX 20600C-3 D	•	6,0	13,0	—	50	6
GSX 20700C-3 D	•	7,0	16,0	21,1	60	8
GSX 20800C-3 D	•	8,0	19,0	—	60	8
GSX 20900C-3 D	•	9,0	19,0	24,1	70	10
GSX 21000C-3 D	•	10,0	22,0	—	70	10
GSX 21200C-3 D	•	12,0	26,0	—	75	12
GSX 21600C-3 D	•	16,0	32,0	—	90	16
GSX 22000C-3 D	•	20,0	40,0	—	100	20

• Euro-Stock ◦ Japan-Stock

Grade: ACF20

■ Recommended Cutting Conditions

1. For stable machining performance use rigid, high-precision machines and holders.
2. Use compressed air when dry machining.
3. Use wet machining for stainless steel, heat resistant alloy, and titanium alloy applications.
4. If chattering is a problem, reduce the Spindle Speed and feed rate indicated in the table below by the same ratio, or reduce the depth of cut.
5. If the machine cannot achieve the recommended spindle speed, please use the max. spindle speed available.

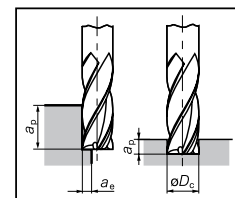

■ Shoulder Milling

Work Material	Structural Steel		Carbon Steel (150 - 250 HB)		Cast Iron		Alloy Steel (25 - 35 HRC)		Tempered Steel, Hardened Steel (35 - 45 HRC)		Hardened Steel (45 - 55 HRC)		Stainless Steel		Heat Resistant Steel Titanium Alloy	
	Spindle Speed (min ⁻¹)	Feed Rate (mm/min ⁻¹)	Spindle Speed (min ⁻¹)	Feed Rate (mm/min ⁻¹)	Spindle Speed (min ⁻¹)	Feed Rate (mm/min ⁻¹)	Spindle Speed (min ⁻¹)	Feed Rate (mm/min ⁻¹)	Spindle Speed (min ⁻¹)	Feed Rate (mm/min ⁻¹)	Spindle Speed (min ⁻¹)	Feed Rate (mm/min ⁻¹)	Spindle Speed (min ⁻¹)	Feed Rate (mm/min ⁻¹)	Spindle Speed (min ⁻¹)	Feed Rate (mm/min ⁻¹)
D _c (mm)																
1,0	16,600	190	16,600	190	16,600	190	15,500	140	10,500	70	7,500	45	9,400	50	7,500	35
2,0	9,500	250	9,500	250	9,500	250	9,000	200	6,200	120	4,500	60	5,200	70	4,500	50
4,0	5,200	330	5,200	330	5,200	330	4,800	200	3,400	150	2,250	75	2,600	90	2,250	65
6,0	3,500	360	3,500	360	3,500	360	3,200	250	2,550	170	1,500	90	1,700	100	1,500	80
8,0	2,600	320	2,600	320	2,600	320	2,400	240	1,900	170	1,100	90	1,300	105	1,100	80
10,0	2,100	300	2,100	300	2,100	300	1,900	230	1,500	170	900	90	1,000	100	900	80
12,0	1,750	280	1,750	280	1,750	280	1,600	230	1,300	170	750	90	850	100	750	80
16,0	1,300	240	1,300	240	1,300	240	1,200	200	950	150	550	75	650	85	550	65
20,0	1,050	220	1,050	220	1,050	220	950	180	750	140	450	70	500	75	450	60
Standard Depth of cut	a _p a _e		2,5 D _c				∅ 3 text 0,1 D _c				2,0 D _c 0,02 D _c					

■ Grooving

Work Material	Structural Steel		Carbon Steel (150 - 250 HB)		Cast Iron		Alloy Steel (25 - 35 HRC)		Tempered Steel, Hardened Steel (35 - 45 HRC)		Hardened Steel (45 - 55 HRC)		Stainless Steel		Heat Resistant Steel Titanium Alloy	
	Spindle Speed (min ⁻¹)	Feed Rate (mm/min ⁻¹)	Spindle Speed (min ⁻¹)	Feed Rate (mm/min ⁻¹)	Spindle Speed (min ⁻¹)	Feed Rate (mm/min ⁻¹)	Spindle Speed (min ⁻¹)	Feed Rate (mm/min ⁻¹)	Spindle Speed (min ⁻¹)	Feed Rate (mm/min ⁻¹)	Spindle Speed (min ⁻¹)	Feed Rate (mm/min ⁻¹)	Spindle Speed (min ⁻¹)	Feed Rate (mm/min ⁻¹)	Spindle Speed (min ⁻¹)	Feed Rate (mm/min ⁻¹)
D _c (mm)																
1,0	16,600	70	16,600	80	16,600	80	15,500	50	10,500	50	7,500	35	9,400	30	3,750	10
2,0	9,500	80	9,500	100	9,500	100	9,000	90	6,200	60	4,500	45	5,200	40	2,250	15
4,0	5,200	120	5,200	150	5,200	150	4,800	120	3,400	80	2,200	50	2,600	50	1,250	20
6,0	3,500	140	3,500	170	3,500	170	3,200	130	2,550	100	1,500	50	1,700	60	950	25
8,0	2,600	140	2,600	160	2,600	160	2,400	130	1,900	100	1,100	50	1,300	60	700	25
10,0	2,100	130	2,100	150	2,100	150	1,900	120	1,500	90	900	50	1,000	60	550	25
12,0	1,750	130	1,750	150	1,750	150	1,600	120	1,300	90	750	50	850	60	450	25
16,0	1,300	110	1,300	130	1,300	130	1,200	110	950	80	550	45	650	50	350	20
20,0	1,050	100	1,050	120	1,050	120	950	100	750	70	450	40	500	40	280	15
Standard Depth of cut	a _p a _e		0,1 D _c				0,2 D _c				0,05 D _c		0,1 D _c			

GSX ENDMILL

GSX 2000C -4 D

Endmill Identification (GSXMILL Series Only)

GSX 2 0100 C - 4 D

Series Code	No. of Teeth	Diameter	Cutting Edge	Cutting Edge Length
General Steel	4	1.0 to 20.0	Standard	10 to 150
Carbon Steel	4	1.0 to 20.0	Standard	10 to 150
Alloy Steel	4	1.0 to 20.0	Standard	10 to 150
Pre-hardened Steel	4	1.0 to 20.0	Standard	10 to 150
Tempered Steel	4	1.0 to 20.0	Standard	10 to 150
Hardened Steel	4	1.0 to 20.0	Standard	10 to 150
Stainless Steel	4	1.0 to 20.0	Standard	10 to 150
Ti Alloy	4	1.0 to 20.0	Standard	10 to 150
Cast Iron	4	1.0 to 20.0	Standard	10 to 150
Al Alloy	4	1.0 to 20.0	Standard	10 to 150
Copper Alloy	4	1.0 to 20.0	Standard	10 to 150
Graphite	4	1.0 to 20.0	Standard	10 to 150

Tolerance	
ϕD_c	Tolerance
$D \leq 3,0$	0 -0,015
$3,0 < D \leq 12$	0 -0,020
$12,0 < D$	0 -0,030

Body

(mm)

Cat. No.	Stock	ϕD_c	l_1	l_2	L	ϕD_c
GSX 20100C-4 D	•	1,0	4,0	5,0	40	4
GSX 20150C-4 D	•	1,5	6,0	7,0	40	4
GSX 20200C-4 D	•	2,0	8,0	9,0	40	4
GSX 20250C-4 D	•	2,5	10,0	11,0	50	4
GSX 20300C-4 D	•	3,0	12,0	13,5	50	6
GSX 20400C-4 D	•	4,0	16,0	17,5	50	6
GSX 20500C-4 D	•	5,0	20,0	22,0	60	6
GSX 20600C-4 D	•	6,0	24,0	—	60	6
GSX 20800C-4 D	•	8,0	32,0	—	80	8
GSX 21000C-4 D	•	10,0	40,0	—	90	10
GSX 21200C-4 D	•	12,0	48,0	—	100	12
GSX 21600C-4 D	•	16,0	64,0	—	120	16
GSX 22000C-4 D	•	20,0	80,0	—	140	20

• Euro-Stock ◦ Japan-Stock

Grade: ACF20

Recommended Cutting Conditions

1. For stable machining performance use rigid, high-precision machines and holders.
2. Use compressed air when dry machining.
3. Use wet machining for stainless steel, heat resistant alloy, and titanium alloy applications.
4. If chattering is a problem, reduce the Spindle Speed and feed rate indicated in the table below by the same ratio, or reduce the depth of cut.
5. If the machine cannot achieve the recommended spindle speed, please use the max. spindle speed available.

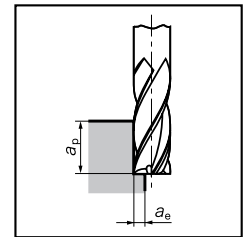

Shoulder Milling

Work Material	Structural Steel		Carbon Steel (150-250 HB)		Cast Iron		Alloy Steel (25-35 HRC)		Tempered Steel, Hardened Steel (35-45 HRC)		Hardened Steel (45-55 HRC)		Stainless Steel		Heat Resistant Steel Titanium Alloy			
	Spindle Speed (min ⁻¹)	Feed Rate (mm/min ⁻¹)	Spindle Speed (min ⁻¹)	Feed Rate (mm/min ⁻¹)	Spindle Speed (min ⁻¹)	Feed Rate (mm/min ⁻¹)	Spindle Speed (min ⁻¹)	Feed Rate (mm/min ⁻¹)	Spindle Speed (min ⁻¹)	Feed Rate (mm/min ⁻¹)	Spindle Speed (min ⁻¹)	Feed Rate (mm/min ⁻¹)	Spindle Speed (min ⁻¹)	Feed Rate (mm/min ⁻¹)	Spindle Speed (min ⁻¹)	Feed Rate (mm/min ⁻¹)		
D _c (mm)																		
1,0	9,000	130	9,000	130	9,000	130	7,000	95	6,500	50	4,500	30	5,400	40	4,500	25		
2,0	4,500	180	4,500	180	4,500	180	3,500	120	3,200	70	2,300	40	2,700	50	2,300	35		
4,0	2,250	240	2,250	240	2,250	240	1,750	160	1,600	95	1,200	60	1,350	65	1,200	40		
6,0	1,500	300	1,500	300	1,500	300	1,150	170	1,050	110	800	70	900	70	800	50		
8,0	1,100	260	1,100	260	1,100	260	850	170	800	110	600	70	660	70	600	50		
10,0	900	250	900	250	900	250	700	160	650	110	460	70	540	70	460	50		
12,0	750	240	750	240	750	240	580	160	520	110	400	70	450	70	400	50		
16,0	550	200	550	200	550	200	440	140	400	95	300	55	330	60	300	45		
20,0	450	180	450	180	450	180	350	120	320	85	240	45	270	50	240	40		
Standard Depth of cut	a_p		$0,08 D_c$				$3,5 D_c$				$0,04 D_c$				$3,0 D_c$			
	a_e																	

■ Endmill Identification (GSXMILL Series Only)

GSX 3 0100 C - 1,5 D

Series Code	No. of Teeth	Diameter	Cutting Edge	Cutting Edge Length
General Steel	Carbon Steel	Alloy Steel	Pre-hardened Steel	Tempered Steel
Hardened Steel	Stainless Steel	Ti Alloy	Heat Resistant Alloy	Cast Iron
Al Alloy	Copper Alloy	Graphite		

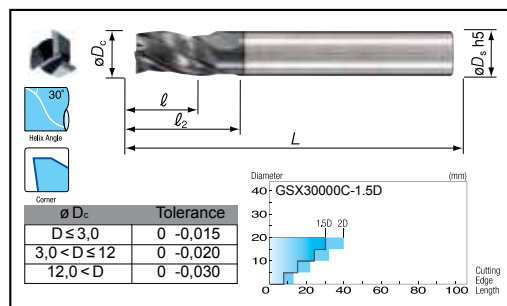

■ Body

(mm)

Cat. No.	Stock	ϕD_c	l_1	l_2	L	ϕD_s
GSX 30100C-1,5 D	•	1,0	1,5	2,5	40	4
GSX 30150C-1,5 D	•	1,5	2,3	3,3	40	4
GSX 30200C-1,5 D	•	2,0	3,0	4,0	40	4
GSX 30250C-1,5 D	•	2,5	3,8	4,8	40	4
GSX 30300C-1,5 D	•	3,0	4,5	6,0	45	6
GSX 30400C-1,5 D	•	4,0	6,0	7,5	45	6
GSX 30500C-1,5 D	•	5,0	7,5	9,5	50	6
GSX 30600C-1,5 D	•	6,0	9,0	-	50	6
GSX 30700C-1,5 D	•	7,0	11,0	13,0	60	8
GSX 30800C-1,5 D	•	8,0	12,0	-	60	8
GSX 30900C-1,5 D	•	9,0	14,0	16,0	70	10
GSX 31000C-1,5 D	•	10,0	15,0	-	70	10
GSX 31200C-1,5 D	•	12,0	18,0	-	75	12
GSX 31600C-1,5 D	•	16,0	24,0	-	90	16
GSX 32000C-1,5 D	•	20,0	30,0	-	100	20

• Euro-Stock ◦ Japan-Stock

Grade: ACF20

■ Recommended Cutting Conditions

1. For stable machining performance use rigid, high-precision machines and holders.
2. Use compressed air when dry machining.
3. Use wet machining for stainless steel, heat resistant alloy, and titanium alloy applications.
4. If chattering is a problem, reduce the Spindle Speed and feed rate indicated in the table below by the same ratio, or reduce the depth of cut.
5. If the machine cannot achieve the recommended spindle speed, please use the max. spindle speed available.

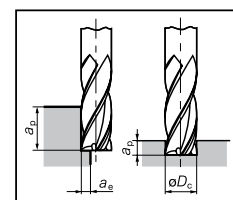

■ Shoulder Milling

Work Material	Structural Steel		Carbon Steel (150 - 250 HB)		Cast Iron		Alloy Steel (25 - 35 HRC)		Tempered Steel, Hardened Steel (35 - 45 HRC)		Hardened Steel (45 - 55 HRC)		Stainless Steel		Heat Resistant Steel Titanium Alloy	
	Spindle Speed (min ⁻¹)	Feed Rate (mm/min ⁻¹)	Spindle Speed (min ⁻¹)	Feed Rate (mm/min ⁻¹)	Spindle Speed (min ⁻¹)	Feed Rate (mm/min ⁻¹)	Spindle Speed (min ⁻¹)	Feed Rate (mm/min ⁻¹)	Spindle Speed (min ⁻¹)	Feed Rate (mm/min ⁻¹)	Spindle Speed (min ⁻¹)	Feed Rate (mm/min ⁻¹)	Spindle Speed (min ⁻¹)	Feed Rate (mm/min ⁻¹)	Spindle Speed (min ⁻¹)	Feed Rate (mm/min ⁻¹)
D _c (mm)																
1,0	19,600	300	19,600	300	19,600	300	18,300	210	12,700	130	9,000	80	11,000	90	9,000	65
2,0	11,200	410	11,200	410	11,200	410	10,500	280	7,300	170	5,300	100	6,400	120	5,300	90
4,0	6,400	550	6,400	550	6,400	550	6,000	370	4,200	230	3,000	140	3,600	150	3,000	120
6,0	4,600	670	4,600	670	4,600	670	4,300	460	3,000	270	2,200	170	2,700	180	2,200	130
8,0	3,400	670	3,400	670	3,400	670	3,200	460	2,200	270	1,600	170	2,000	180	1,600	130
10,0	2,800	670	2,800	670	2,800	670	2,600	460	1,800	270	1,300	170	1,600	180	1,300	130
12,0	2,300	670	2,300	670	2,300	670	2,200	460	1,500	270	1,100	170	1,300	180	1,100	130
16,0	1,700	550	1,700	550	1,700	550	1,600	370	1,100	230	800	140	1,000	150	800	100
20,0	1,350	490	1,350	490	1,350	490	1,300	330	900	210	650	120	800	130	650	90
Standard Depth of cut	a_p a_e		$1,5 D_c$ $0,05 D_c$				$1,0 D_c$ $0,02 D_c$									

n Grooving

Work Material	Structural Steel		Carbon Steel (150 - 250 HB)		Cast Iron		Alloy Steel (25 - 35 HRC)		Tempered Steel, Hardened Steel (35 - 45 HRC)		Hardened Steel (45 - 55 HRC)		Stainless Steel		Heat Resistant Steel Titanium Alloy	
	Spindle Speed (min ⁻¹)	Feed Rate (mm/min ⁻¹)	Spindle Speed (min ⁻¹)	Feed Rate (mm/min ⁻¹)	Spindle Speed (min ⁻¹)	Feed Rate (mm/min ⁻¹)	Spindle Speed (min ⁻¹)	Feed Rate (mm/min ⁻¹)	Spindle Speed (min ⁻¹)	Feed Rate (mm/min ⁻¹)	Spindle Speed (min ⁻¹)	Feed Rate (mm/min ⁻¹)	Spindle Speed (min ⁻¹)	Feed Rate (mm/min ⁻¹)	Spindle Speed (min ⁻¹)	Feed Rate (mm/min ⁻¹)
D _c (mm)																
1,0	19,600	240	19,600	300	19,600	300	18,300	210	12,700	130	9,000	35	11,000	65	9,000	25
2,0	11,200	320	11,200	410	11,200	410	10,500	280	7,300	170	5,300	45	6,400	85	5,300	35
4,0	6,400	450	6,400	550	6,400	550	6,000	370	4,200	230	3,000	50	3,600	100	3,000	50
6,0	4,600	540	4,600	670	4,600	670	4,300	460	3,000	270	2,200	50	2,700	130	2,200	55
8,0	3,400	540	3,400	670	3,400	670	3,200	460	2,200	270	1,600	50	2,000	130	1,600	55
10,0	2,800	540	2,800	670	2,800	670	2,600	460	1,800	270	1,300	50	1,600	130	1,300	55
12,0	2,300	540	2,300	670	2,300	670	2,200	460	1,500	270	1,100	50	1,300	130	1,100	55
16,0	1,700	440	1,700	550	1,700	550	1,600	370	1,100	230	800	45	1,000	110	800	45
20,0	1,350	390	1,350	490	1,350	490	1,300	330	900	210	650	40	800	90	650	40
Standard Depth of cut	a_p a_e		$0,2 D_c$				$0,5 D_c$				$0,2 D_c$		$0,05 D_c$		$0,2 D_c$	

GSX ENDMILL

GSX 3000C-2 D

Endmill Identification (GSXMILL Series Only)

GSX 3 0100 C - 2 D

Series Code	No. of Teeth	Diameter	Cutting Edge	Cutting Edge Length
General Steel	Carbon Steel	Alloy Steel	Pre-hardened Steel	Tempered Steel
45 to 55 HRC	55 to 60 HRC	60 to 65 HRC	Stainless Steel	Ti Alloy Heat Resistant Alloy
Cast Iron	Al Alloy	Copper Alloy	Graphite	

ϕD_c	Tolerance
$D \leq 3,0$	0 -0,015
$3,0 < D \leq 12$	0 -0,020
$12,0 < D$	0 -0,030

Body

(mm)

Cat. No.	Stock	ϕD_c	l_1	l_2	L	ϕD_c
GSX 30100C-2D	•	1,0	2,5	3,5	40	4
GSX 30150C-2D	•	1,5	3,8	4,8	40	4
GSX 30200C-2D	•	2,0	5,0	6,0	40	4
GSX 30250C-2D	•	2,5	6,3	7,3	40	4
GSX 30300C-2D	•	3,0	7,5	9,0	45	6
GSX 30400C-2D	•	4,0	11,0	12,5	45	6
GSX 30500C-2D	•	5,0	13,0	15,0	50	6
GSX 30600C-2D	•	6,0	13,0	-	50	6
GSX 30700C-2D	•	7,0	16,0	18,0	60	8
GSX 30800C-2D	•	8,0	19,0	-	60	8
GSX 30900C-2D	•	9,0	19,0	21,0	70	10
GSX 31000C-2D	•	10,0	22,0	-	70	10
GSX 31200C-2D	•	12,0	26,0	-	75	12
GSX 31600C-2D	◦	16,0	32,0	-	90	16
GSX 32000C-2D	◦	20,0	40,0	-	100	20

• Euro-Stock ◦ Japan-Stock

Grade: ACF20

Recommended Cutting Conditions

- For stable machining performance use rigid, high-precision machines and holders.
- Use compressed air when dry machining.
- Use wet machining for stainless steel, heat resistant alloy, and titanium alloy applications.
- If chattering is a problem, reduce the Spindle Speed and feed rate indicated in the table below by the same ratio, or reduce the depth of cut.
- If the machine cannot achieve the recommended spindle speed, please use the max. spindle speed available.

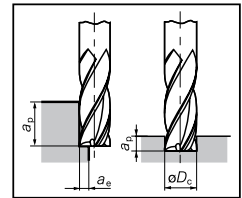

Shoulder Milling

Work Material	Structural Steel		Carbon Steel (150-250 HB)		Cast Iron		Alloy Steel (25-35 HRC)		Tempered Steel, Hardened Steel (35-45 HRC)		Hardened Steel (45-55 HRC)		Stainless Steel		Heat Resistant Steel Titanium Alloy	
	Spindle Speed (min ⁻¹)	Feed Rate (mm/min ⁻¹)	Spindle Speed (min ⁻¹)	Feed Rate (mm/min ⁻¹)	Spindle Speed (min ⁻¹)	Feed Rate (mm/min ⁻¹)	Spindle Speed (min ⁻¹)	Feed Rate (mm/min ⁻¹)	Spindle Speed (min ⁻¹)	Feed Rate (mm/min ⁻¹)	Spindle Speed (min ⁻¹)	Feed Rate (mm/min ⁻¹)	Spindle Speed (min ⁻¹)	Feed Rate (mm/min ⁻¹)	Spindle Speed (min ⁻¹)	Feed Rate (mm/min ⁻¹)
Dc (mm)																
1,0	19,600	300	19,600	300	19,600	300	18,300	210	12,700	130	9,000	80	11,000	90	9,000	65
2,0	11,200	410	11,200	410	11,200	410	10,500	280	7,300	170	5,300	100	6,400	120	5,300	90
4,0	6,400	550	6,400	550	6,400	550	6,000	370	4,200	230	3,000	140	3,600	150	3,000	120
6,0	4,600	670	4,600	670	4,600	670	4,300	460	3,000	270	2,200	170	2,700	180	2,200	130
8,0	3,400	670	3,400	670	3,400	670	3,200	460	2,200	270	1,600	170	2,000	180	1,600	130
10,0	2,800	670	2,800	670	2,800	670	2,600	460	1,800	270	1,300	170	1,600	180	1,300	130
12,0	2,300	670	2,300	670	2,300	670	2,200	460	1,500	270	1,100	170	1,300	180	1,100	130
16,0	1,700	550	1,700	550	1,700	550	1,600	370	1,100	230	800	140	1,000	150	800	100
20,0	1,350	490	1,350	490	1,350	490	1,300	330	900	210	650	120	800	130	650	90
Standard Depth of cut	ap				1,5 Dc								1,0 Dc			
	ae				0,05 Dc								0,02 Dc			

Grooving

Work Material	Structural Steel		Carbon Steel (150-250 HB)		Cast Iron		Alloy Steel (25-35 HRC)		Tempered Steel, Hardened Steel (35-45 HRC)		Hardened Steel (45-55 HRC)		Stainless Steel		Heat Resistant Steel Titanium Alloy	
	Spindle Speed (min ⁻¹)	Feed Rate (mm/min ⁻¹)	Spindle Speed (min ⁻¹)	Feed Rate (mm/min ⁻¹)	Spindle Speed (min ⁻¹)	Feed Rate (mm/min ⁻¹)	Spindle Speed (min ⁻¹)	Feed Rate (mm/min ⁻¹)	Spindle Speed (min ⁻¹)	Feed Rate (mm/min ⁻¹)	Spindle Speed (min ⁻¹)	Feed Rate (mm/min ⁻¹)	Spindle Speed (min ⁻¹)	Feed Rate (mm/min ⁻¹)	Spindle Speed (min ⁻¹)	Feed Rate (mm/min ⁻¹)
Dc (mm)																
1,0	19,600	240	19,600	300	19,600	300	18,300	210	12,700	130	9,000	80	11,000	65	4,500	25
2,0	11,200	320	11,200	410	11,200	410	10,500	280	7,300	170	5,300	100	6,400	85	2,650	35
4,0	6,400	450	6,400	550	6,400	550	6,000	370	4,200	230	3,000	140	3,600	100	1,500	50
6,0	4,600	540	4,600	670	4,600	670	4,300	460	3,000	270	2,200	170	2,700	130	1,000	55
8,0	3,400	540	3,400	670	3,400	670	3,200	460	2,200	270	1,600	170	2,000	130	800	55
10,0	2,800	540	2,800	670	2,800	670	2,600	460	1,800	270	1,300	170	1,600	130	650	55
12,0	2,300	540	2,300	670	2,300	670	2,200	460	1,500	270	1,100	170	1,300	130	500	55
16,0	1,700	440	1,700	550	1,700	550	1,600	370	1,100	230	800	140	1,000	110	400	45
20,0	1,350	390	1,350	490	1,350	490	1,300	330	900	210	650	120	800	90	320	40
Standard Depth of cut	ap															
	ae	0,2 Dc			0,5 Dc				0,2 Dc		0,05 Dc			0,2 Dc		

■ Endmill Identification (GSXMILL Series Only)

GSXSLT 3 0100 C - 1,5D

Series Code	No. of Teeth	Diameter	Cutting Edge	Cutting Edge Length
General Steel	45 to 55 HRC	60 to 65 HRC	Stainless Steel	Graphite
Carbon Steel	55 to 60 HRC	60 to 65 HRC	Ti Alloy	Copper Alloy
Alloy Steel	60 to 65 HRC	60 to 65 HRC	Cast Iron	Al Alloy
Pre-hardened Steel	45 to 55 HRC	60 to 65 HRC	High resistance Alloy	
Tempered Steel Die Steel	45 to 55 HRC	60 to 65 HRC		

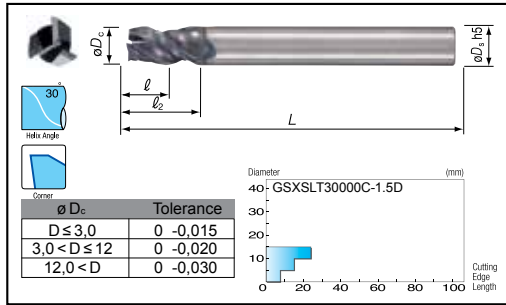

■ Body

(mm)

Cat. No.	Stock	ϕD_c	l_1	l_2	L	ϕD_s
GSXSLT 30100C-1.5D	•	1.0	1.5	2.5	40	4
GSXSLT 30150C-1.5D	•	1.5	2.3	3.3	40	4
GSXSLT 30200C-1.5D	•	2.0	3.0	4.0	40	4
GSXSLT 30250C-1.5D	•	2.5	3.8	4.8	40	4
GSXSLT 30300C-1.5D	•	3.0	4.5	6.0	45	6
GSXSLT 30400C-1.5D	•	4.0	6.0	7.5	45	6
GSXSLT 30500C-1.5D	•	5.0	7.5	9.5	50	6
GSXSLT 30600C-1.5D	•	6.0	9.0	-	50	6
GSXSLT 30700C-1.5D	•	7.0	11.0	13.0	60	8
GSXSLT 30800C-1.5D	•	8.0	12.0	-	60	8
GSXSLT 30900C-1.5D	•	9.0	14.0	16.0	70	10
GSXSLT 31000C-1.5D	•	10.0	15.0	-	70	10
GSXSLT 31200C-1.5D	•	12.0	18.0	-	75	12
GSXSLT 31600C-1.5D	◦	16.0	24.0	-	90	16

• Euro-Stock ◦ Japan-Stock

Grade: ACF20

■ Recommended Cutting Conditions

page 10

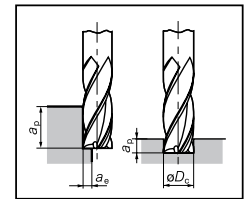

■ Shoulder Milling

Work Material	Structural Steel		Carbon Steel (150 - 250 HB)		Cast Iron		Alloy Steel (25 - 35 HRC)		Tempered Steel, Hardened Steel (35 - 45 HRC)		Hardened Steel (45 - 55 HRC)		Stainless Steel		Heat Resistant Steel Titanium Alloy	
	Spindle Speed (min ⁻¹)	Feed Rate (mm/min ⁻¹)	Spindle Speed (min ⁻¹)	Feed Rate (mm/min ⁻¹)	Spindle Speed (min ⁻¹)	Feed Rate (mm/min ⁻¹)	Spindle Speed (min ⁻¹)	Feed Rate (mm/min ⁻¹)	Spindle Speed (min ⁻¹)	Feed Rate (mm/min ⁻¹)	Spindle Speed (min ⁻¹)	Feed Rate (mm/min ⁻¹)	Spindle Speed (min ⁻¹)	Feed Rate (mm/min ⁻¹)	Spindle Speed (min ⁻¹)	Feed Rate (mm/min ⁻¹)
Conditions																
D_c (mm)																
1,0	19,600	300	19,600	300	19,600	300	18,300	210	12,700	130	9,000	80	11,000	90	9,000	65
2,0	11,200	410	11,200	410	11,200	410	10,500	280	7,300	170	5,300	100	6,400	120	5,300	90
4,0	6,400	550	6,400	550	6,400	550	6,000	370	4,200	230	3,000	140	3,600	150	3,000	120
6,0	4,600	670	4,600	670	4,600	670	4,300	460	3,000	270	2,200	170	2,700	180	2,200	130
8,0	3,400	670	3,400	670	3,400	670	3,200	460	2,200	270	1,600	170	2,000	180	1,600	130
10,0	2,800	670	2,800	670	2,800	670	2,600	460	1,800	270	1,300	170	1,600	180	1,300	130
12,0	2,300	670	2,300	670	2,300	670	2,200	460	1,500	270	1,100	170	1,300	180	1,100	130
16,0	1,700	550	1,700	550	1,700	550	1,600	370	1,100	230	800	140	1,000	150	800	100
Standard Depth of cut	a_p				$1,5 D_c$				$1,0 D_c$				$0,05 D_c$			
	a_e				$0,05 D_c$				$0,02 D_c$				$0,02 D_c$			

■ Grooving

Work Material	Structural Steel		Carbon Steel (150 - 250 HB)		Cast Iron		Alloy Steel (25 - 35 HRC)		Tempered Steel, Hardened Steel (35 - 45 HRC)		Hardened Steel (45 - 55 HRC)		Stainless Steel		Heat Resistant Steel Titanium Alloy	
	Spindle Speed (min ⁻¹)	Feed Rate (mm/min ⁻¹)	Spindle Speed (min ⁻¹)	Feed Rate (mm/min ⁻¹)	Spindle Speed (min ⁻¹)	Feed Rate (mm/min ⁻¹)	Spindle Speed (min ⁻¹)	Feed Rate (mm/min ⁻¹)	Spindle Speed (min ⁻¹)	Feed Rate (mm/min ⁻¹)	Spindle Speed (min ⁻¹)	Feed Rate (mm/min ⁻¹)	Spindle Speed (min ⁻¹)	Feed Rate (mm/min ⁻¹)	Spindle Speed (min ⁻¹)	Feed Rate (mm/min ⁻¹)
Conditions																
D_c (mm)																
1,0	19,600	240	19,600	300	19,600	300	18,300	210	12,700	130	9,000	80	11,000	65	4,500	25
2,0	11,200	320	11,200	410	11,200	410	10,500	280	7,300	170	5,300	100	6,400	85	2,650	35
4,0	6,400	450	6,400	550	6,400	550	6,000	370	4,200	230	3,000	140	3,600	100	1,500	50
6,0	4,600	540	4,600	670	4,600	670	4,300	460	3,000	270	2,200	170	2,700	130	1,150	55
8,0	3,400	540	3,400	670	3,400	670	3,200	460	2,200	270	1,600	170	2,000	130	800	55
10,0	2,800	540	2,800	670	2,800	670	2,600	460	1,800	270	1,300	170	1,600	130	650	55
12,0	2,300	540	2,300	670	2,300	670	2,200	460	1,500	270	1,100	170	1,300	130	500	55
16,0	1,700	440	1,700	550	1,700	550	1,600	370	1,100	230	800	140	1,000	110	400	45
Standard Depth of cut	a_p		$0,2 D_c$		$0,5 D_c$		$0,2 D_c$		$0,05 D_c$		$0,05 D_c$		$0,2 D_c$			
	a_e		$0,2 D_c$		$0,5 D_c$		$0,2 D_c$		$0,05 D_c$		$0,05 D_c$		$0,2 D_c$			

■ Slot Milling

Work Material	Structural Steel		Carbon Steel (150 - 250 HB)		Cast Iron		Alloy Steel (25 - 35 HRC)		Tempered Steel, Hardened Steel (35 - 45 HRC)		Hardened Steel (45 - 55 HRC)		Stainless Steel		Heat Resistant Steel Titanium Alloy	
	Spindle Speed (min ⁻¹)	Feed Rate (mm/min ⁻¹)	Spindle Speed (min ⁻¹)	Feed Rate (mm/min ⁻¹)	Spindle Speed (min ⁻¹)	Feed Rate (mm/min ⁻¹)	Spindle Speed (min ⁻¹)	Feed Rate (mm/min ⁻¹)	Spindle Speed (min ⁻¹)	Feed Rate (mm/min ⁻¹)	Spindle Speed (min ⁻¹)	Feed Rate (mm/min ⁻¹)	Spindle Speed (min ⁻¹)	Feed Rate (mm/min ⁻¹)	Spindle Speed (min ⁻¹)	Feed Rate (mm/min ⁻¹)
Conditions																
D_c (mm)																
1,0	19,600	70	19,600	90	19,600	90	18,300	60	12,700	40	9,000	25	11,000	20	4,500	10
2,0	11,200	90	11,200	130	11,200	130	10,500	80	7,300	50	5,300	30	6,400	25	2,650	15
4,0	6,400	130	6,400	160	6,400	160	6,000	110	4,200	70	3,000	40	3,600	30	1,500	20
6,0	4,600	160	4,600	200	4,600	200	4,300	130	3,000	80	2,200	50	2,700	40	1,150	20
8,0	3,400	160	3,400	200	3,400	200	3,200	130	2,200	80	1,600	50	2,000	40	800	20
10,0	2,800	160	2,800	200	2,800	200	2,600	130	1,800	80	1,300	50	1,600	40	650	20
12,0	2,300	160	2,300	200	2,300	200	2,200	130	1,500	80	1,100	50	1,300	40	500	20
16,0	1,700	130	1,700	160	1,700	160	1,600	110	1,100	70	800	40	1,000	35	400	15

■ Endmill Identification (GSXMILL Series Only)

GSX 4 0100 S - 2 D

Series Code No. of Teeth Diameter Cutting Edge Cutting Edge Length

General Steel	Carbon Steel	Alloy Steel	Pre-hardened Steel	Tempered Steel	Die Steel	Hardened Steel	Stainless Steel	Ti Alloy	Heat Resistant Alloy	Cast Iron	Al Alloy	Copper Alloy	Graphite
•	•	•	•	•	•	45 to 55 HRC	55 to 60 HRC	60 to 65 HRC	•	•	•	•	•

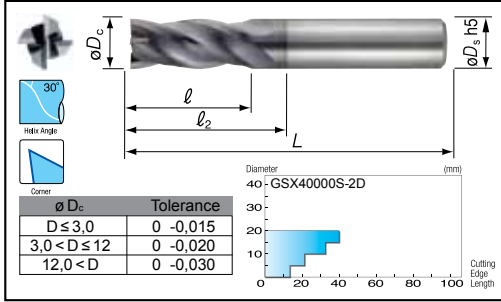

■ Body

(mm)

Cat. No.	Stock	∅ D _c	l ₁	l ₂	L	∅ D _s
GSX 40100S-2D	•	1,0	2,5	3,5	40	4
GSX 40150S-2D	•	1,5	3,8	4,8	40	4
GSX 40200S-2D	•	2,0	5,0	6,0	40	4
GSX 40250S-2D	•	2,5	6,3	7,3	40	4
GSX 40300S-2D	•	3,0	7,5	9,0	45	6
GSX 40350S-2D	•	3,5	8,8	10,0	45	6
GSX 40400S-2D	•	4,0	11,0	14,0	45	6
GSX 40450S-2D	•	4,5	11,3	12,8	50	6
GSX 40500S-2D	•	5,0	13,0	19,6	50	6
GSX 40550S-2D	•	5,5	13,0	19,6	50	6
GSX 40600S-2D	•	6,0	13,0	—	50	6
GSX 40700S-2D	•	7,0	16,0	21,1	60	8
GSX 40800S-2D	•	8,0	19,0	—	60	8
GSX 40900S-2D	•	9,0	19,0	24,1	70	10
GSX 41000S-2D	•	10,0	22,0	—	70	10
GSX 41200S-2D	•	12,0	26,0	—	75	12
GSX 41600S-2D	•	16,0	32,0	—	90	16
GSX 42000S-2D	•	20,0	40,0	—	100	20

• Euro-Stock ◦ Japan-Stock

Grade: ACF20

■ Recommended Cutting Conditions

1. For stable machining performance use rigid, high-precision machines and holders.
2. Use compressed air when dry machining.
3. Use wet machining for stainless steel, heat resistant alloy, and titanium alloy applications.
4. If chattering is a problem, reduce the Spindle Speed and feed rate indicated in the table below by the same ratio, or reduce the depth of cut.
5. If the machine cannot achieve the recommended spindle speed, please use the max. spindle speed available.

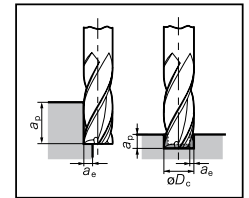

■ Shoulder Milling

Work Material	Structural Steel		Carbon Steel (150 - 250 HB)		Cast Iron		Alloy Steel (25 - 35 HRC)		Tempered Steel, Hardened Steel (35 - 45 HRC)		Hardened Steel (45 - 55 HRC)		Stainless Steel		Heat Resistant Steel Titanium Alloy	
	Spindle Speed (min ⁻¹)	Feed Rate (mm/min ⁻¹)	Spindle Speed (min ⁻¹)	Feed Rate (mm/min ⁻¹)	Spindle Speed (min ⁻¹)	Feed Rate (mm/min ⁻¹)	Spindle Speed (min ⁻¹)	Feed Rate (mm/min ⁻¹)	Spindle Speed (min ⁻¹)	Feed Rate (mm/min ⁻¹)	Spindle Speed (min ⁻¹)	Feed Rate (mm/min ⁻¹)	Spindle Speed (min ⁻¹)	Feed Rate (mm/min ⁻¹)	Spindle Speed (min ⁻¹)	Feed Rate (mm/min ⁻¹)
D _c (mm)																
1,0	22,000	360	22,000	360	22,000	360	19,000	220	13,000	140	9,500	90	11,300	90	9,500	65
2,0	11,500	440	11,500	440	11,500	440	11,000	290	7,500	180	5,400	110	6,500	120	5,400	85
4,0	6,000	560	6,000	560	6,000	560	5,800	370	4,000	230	2,900	150	3,400	160	2,900	100
6,0	4,200	600	4,200	600	4,200	600	4,000	400	2,700	240	2,000	160	2,400	170	2,000	120
8,0	3,000	600	3,000	600	3,000	600	2,800	400	2,000	240	1,450	160	1,800	170	1,450	120
10,0	2,500	600	2,500	600	2,500	600	2,350	400	1,600	240	1,200	160	1,450	170	1,200	120
12,0	2,100	600	2,100	600	2,100	600	2,000	400	1,350	240	1,000	160	1,200	170	1,000	120
16,0	1,500	500	1,500	500	1,500	500	1,450	320	1,000	210	750	130	900	140	750	90
20,0	1,200	460	1,200	460	1,200	460	1,150	290	800	200	600	110	700	120	600	75
Standard Depth of cut	a _p a _e		0,03 D _c				2,0 D _c				0,01 D _c					

■ Grooving

Work Material	Structural Steel		Carbon Steel (150 - 250 HB)		Cast Iron		Alloy Steel (25 - 35 HRC)		Tempered Steel, Hardened Steel (35 - 45 HRC)		Hardened Steel (45 - 55 HRC)		Stainless Steel		Heat Resistant Steel Titanium Alloy	
	Spindle Speed (min ⁻¹)	Feed Rate (mm/min ⁻¹)	Spindle Speed (min ⁻¹)	Feed Rate (mm/min ⁻¹)	Spindle Speed (min ⁻¹)	Feed Rate (mm/min ⁻¹)	Spindle Speed (min ⁻¹)	Feed Rate (mm/min ⁻¹)	Spindle Speed (min ⁻¹)	Feed Rate (mm/min ⁻¹)	Spindle Speed (min ⁻¹)	Feed Rate (mm/min ⁻¹)	Spindle Speed (min ⁻¹)	Feed Rate (mm/min ⁻¹)	Spindle Speed (min ⁻¹)	Feed Rate (mm/min ⁻¹)
D _c (mm)																
1,0	22,000	360	22,000	360	22,000	360	19,000	220	13,000	140	9,500	90	11,300	90	9,500	65
2,0	11,500	440	11,500	440	11,500	440	11,000	290	7,500	180	5,400	110	6,500	120	5,400	85
4,0	6,000	560	6,000	560	6,000	560	5,800	370	4,000	230	2,900	150	3,400	160	2,900	100
6,0	4,200	600	4,200	600	4,200	600	4,000	400	2,700	240	2,000	160	2,400	170	2,000	120
8,0	3,000	600	3,000	600	3,000	600	2,800	400	2,000	240	1,450	160	1,800	170	1,450	120
10,0	2,500	600	2,500	600	2,500	600	2,350	400	1,600	240	1,200	160	1,450	170	1,200	120
12,0	2,100	600	2,100	600	2,100	600	2,000	400	1,350	240	1,000	160	1,200	170	1,000	120
16,0	1,500	500	1,500	500	1,500	500	1,450	320	1,000	210	750	130	900	140	750	90
20,0	1,200	460	1,200	460	1,200	460	1,150	290	800	200	600	110	700	120	600	75
Standard Depth of cut	a _p a _e		1,5 D _c				0,02 D _c									

GSX ENDMILL

GSX 4000C-2 D

Endmill Identification (GSXMILL Series Only)

GSX 4 0100 C - 2 D

Series Code No. of Teeth Diameter Cutting Edge Cutting Edge Length

General Steel	Carbon Steel	Alloy Steel	Pre-hardened Steel	Tempered Steel	Hardened Steel	Stainless Steel	Ti Alloy	Cast Iron	Al Alloy	Copper Alloy	Graphite
•	•	•	•	•	45 to 65 HRC	55 to 65 HRC	60 to 65 HRC	•	•	•	•

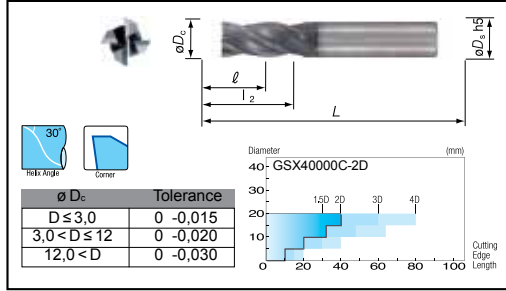

Body

(mm)

Cat. No.	Stock	Ø Dc	l ₁	l ₂	L	Ø Dc
GSX 40100C-2D	•	1,0	2,0	3,0	40	4
GSX 40150C-2D	•	1,5	3,0	4,0	40	4
GSX 40200C-2D	•	2,0	4,0	5,0	40	4
GSX 40250C-2D	•	2,5	5,0	6,0	40	4
GSX 40300C-2D	•	3,0	6,0	7,5	45	6
GSX 40350C-2D	•	3,5	7,0	8,5	45	6
GSX 40400C-2D	•	4,0	8,0	9,5	45	6
GSX 40450C-2D	•	4,5	9,0	10,5	50	6
GSX 40500C-2D	•	5,0	10,0	12,0	50	6
GSX 40550C-2D	•	5,5	11,0	13,0	50	6
GSX 40600C-2D	•	6,0	12,0	—	50	6
GSX 40700C-2D	•	7,0	14,0	16,0	60	8
GSX 40800C-2D	•	8,0	16,0	—	60	8
GSX 40900C-2D	•	9,0	18,0	20,0	70	10
GSX 41000C-2D	•	10,0	20,0	—	70	10
GSX 41200C-2D	•	12,0	24,0	—	75	12
GSX 41400C-2D	•	14,0	28,0	31,5	90	16
GSX 41500C-2D	•	15,0	30,0	33,5	90	16
GSX 41600C-2D	•	16,0	32,0	—	90	16
GSX 42000C-2D	•	20,0	40,0	—	100	20

• Euro-Stock • Japan-Stock

Grade: ACF20

Recommended Cutting Conditions

page 15

Shoulder Milling

Work Material	Structural Steel	Carbon Steel (150 - 250 HB)		Cast Iron		Alloy Steel (25 - 35 HRC)		Tempered Steel, Hardened Steel (35 - 45 HRC)		Hardened Steel (45 - 55 HRC)		Stainless Steel		Heat Resistant Steel Titanium Alloy		
		Spindle Speed (min ⁻¹)	Feed Rate (mm/min ⁻¹)	Spindle Speed (min ⁻¹)	Feed Rate (mm/min ⁻¹)	Spindle Speed (min ⁻¹)	Feed Rate (mm/min ⁻¹)	Spindle Speed (min ⁻¹)	Feed Rate (mm/min ⁻¹)	Spindle Speed (min ⁻¹)	Feed Rate (mm/min ⁻¹)	Spindle Speed (min ⁻¹)	Feed Rate (mm/min ⁻¹)	Spindle Speed (min ⁻¹)	Feed Rate (mm/min ⁻¹)	
1,0	24,000	470	24,000	470	24,000	470	21,000	290	14,500	180	10,500	120	12,600	120	10,500	85
2,0	12,800	570	12,800	570	12,800	570	12,000	380	8,300	230	6,000	150	7,200	160	6,000	110
4,0	6,800	730	6,800	730	6,800	730	5,400	490	4,400	300	3,200	200	3,800	210	3,200	130
6,0	4,600	780	4,600	780	4,600	780	4,300	520	3,000	320	2,200	210	2,650	220	2,200	150
8,0	3,400	780	3,400	780	3,400	780	3,200	520	2,200	320	1,600	210	2,000	220	1,600	150
10,0	2,800	780	2,800	780	2,800	780	2,600	520	1,800	320	1,300	210	1,600	220	1,300	150
12,0	2,300	780	2,300	780	2,300	780	2,200	520	1,500	320	1,100	210	1,300	220	1,100	150
16,0	1,700	560	1,700	560	1,700	560	1,600	420	1,100	280	800	170	1,000	180	800	120
20,0	1,350	600	1,350	600	1,350	600	1,300	380	900	260	650	150	800	160	650	100
Standard Depth of cut	a _p	1,5 D _c						0,05 D _c		1,0 D _c		0,02 D _c				

Shoulder Milling (High Speed Machining Centre)

Work Material	Structural Steel	Carbon Steel (150 - 250 HB)		Cast Iron		Alloy Steel (25 - 35 HRC)		Tempered Steel, Hardened Steel (35 - 45 HRC)		Hardened Steel (45 - 55 HRC)		Stainless Steel		Heat Resistant Steel Titanium Alloy		
		Spindle Speed (min ⁻¹)	Feed Rate (mm/min ⁻¹)	Spindle Speed (min ⁻¹)	Feed Rate (mm/min ⁻¹)	Spindle Speed (min ⁻¹)	Feed Rate (mm/min ⁻¹)	Spindle Speed (min ⁻¹)	Feed Rate (mm/min ⁻¹)	Spindle Speed (min ⁻¹)	Feed Rate (mm/min ⁻¹)	Spindle Speed (min ⁻¹)	Feed Rate (mm/min ⁻¹)	Spindle Speed (min ⁻¹)	Feed Rate (mm/min ⁻¹)	
1,0	60,000	1,200	60,000	1,200	60,000	1,200	60,000	850	60,000	720	48,000	500	32,000	300	—	—
2,0	47,800	2,200	47,800	2,200	47,800	2,200	47,800	1,600	39,800	1,200	31,800	900	15,900	400	—	—
4,0	23,900	2,600	23,900	2,600	23,900	2,600	23,900	1,900	19,900	1,400	15,900	1,100	8,000	490	—	—
6,0	16,000	2,700	16,000	2,700	16,000	2,700	16,000	2,000	13,300	1,500	10,600	1,200	5,300	520	—	—
8,0	12,000	2,700	12,000	2,700	12,000	2,700	12,000	2,000	10,000	1,500	8,000	1,200	4,000	520	—	—
10,0	9,600	2,700	9,600	2,700	9,600	2,700	9,600	2,000	8,800	1,500	6,400	1,200	3,200	520	—	—
12,0	8,000	2,700	8,000	2,700	8,000	2,700	8,000	2,000	6,700	1,500	5,300	1,200	2,700	520	—	—
16,0	6,000	2,200	6,000	2,200	6,000	2,200	6,000	1,600	5,000	1,200	4,000	900	2,000	450	—	—
20,0	4,800	2,000	4,800	2,000	4,800	2,000	4,800	1,400	4,000	1,100	3,200	750	1,600	380	—	—
Standard Depth of cut	a _p	1,5 D _c						0,05 D _c		1,0 D _c		0,02 D _c				

Grooving

Work Material	Structural Steel	Carbon Steel (150 - 250 HB)		Cast Iron		Alloy Steel (25 - 35 HRC)		Tempered Steel, Hardened Steel (35 - 45 HRC)		Hardened Steel (45 - 55 HRC)		Stainless Steel		Heat Resistant Steel Titanium Alloy		
		Spindle Speed (min ⁻¹)	Feed Rate (mm/min ⁻¹)	Spindle Speed (min ⁻¹)	Feed Rate (mm/min ⁻¹)	Spindle Speed (min ⁻¹)	Feed Rate (mm/min ⁻¹)	Spindle Speed (min ⁻¹)	Feed Rate (mm/min ⁻¹)	Spindle Speed (min ⁻¹)	Feed Rate (mm/min ⁻¹)	Spindle Speed (min ⁻¹)	Feed Rate (mm/min ⁻¹)	Spindle Speed (min ⁻¹)	Feed Rate (mm/min ⁻¹)	
1,0	24,000	380	24,000	470	24,000	470	21,000	290	14,500	180	10,500	120	12,600	85	5,200	30
2,0	12,800	460	12,800	570	12,800	570	12,000	380	8,300	230	6,000	150	7,200	110	3,000	40
4,0	6,800	580	6,800	730	6,800	730	5,400	490	4,400	300	3,200	200	3,800	130	1,600	55
6,0	4,600	620	4,600	780	4,600	780	4,300	520	3,000	320	2,200	210	2,650	160	1,100	65
8,0	3,400	620	3,400	780	3,400	780	3,200	520	2,200	320	1,600	210	2,000	160	800	65
10,0	2,800	620	2,800	780	2,800	780	2,600	520	1,800	320	1,300	210	1,600	160	650	65
12,0	2,300	620	2,300	780	2,300	780	2,200	520	1,500	320	1,100	210	1,300	160	500	65
16,0	1,700	520	1,700	560	1,700	560	1,600	420	1,100	280	800	170	1,000	130	400	55
20,0	1,350	480	1,350	600	1,350	600	1,300	380	900	260	650	150	800	110	320	50
Standard Depth of cut	a _p	0,2 D _c		0,5 D _c		0,2 D _c		0,05 D _c		0,2 D _c		0,2 D _c				

■ Endmill Identification (GSXMILL Series Only)

GSX 4 0100 C - 3 D

Series Code No. of Teeth Diameter Cutting Edge Cutting Edge Length

General Steel	Carbon Steel	Alloy Steel	Pre-hardened Steel	Tempered Steel	Die Steel	Hardened Steel	Stainless Steel	Ti Alloy	Heat Resistant Alloy	Cast Iron	Al Alloy	Copper Alloy	Graphite
•	•	•	•	•	•	•	•	•	•	•	•	•	•

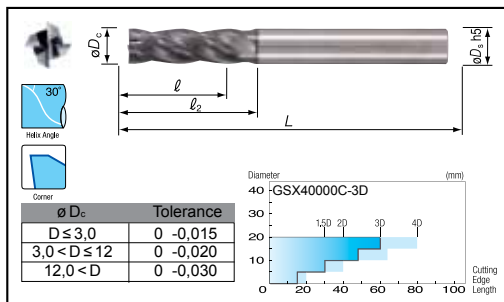

■ Body

(mm)

Cat. No.	Stock	∅ D _c	l ₁	l ₂	L	∅ D _s
GSX 40100C-3 D	•	1,0	3,0	4,0	40	4
GSX 40150C-3 D	•	1,5	4,5	5,5	40	4
GSX 40200C-3 D	•	2,0	6,0	7,0	40	4
GSX 40250C-3 D	•	2,5	7,5	8,5	40	4
GSX 40300C-3 D	•	3,0	9,0	10,5	50	6
GSX 40400C-3 D	•	4,0	12,0	13,5	50	6
GSX 40500C-3 D	•	5,0	15,0	17,0	50	6
GSX 40600C-3 D	•	6,0	18,0	—	50	6
GSX 40800C-3 D	•	8,0	24,0	—	70	8
GSX 41000C-3 D	•	10,0	30,0	—	90	10
GSX 41200C-3 D	•	12,0	36,0	—	90	12
GSX 41600C-3 D	•	16,0	48,0	—	110	16
GSX 42000C-3 D	•	20,0	60,0	—	120	20

• Euro-Stock ◦ Japan-Stock

Grade: ACF20

■ Recommended Cutting Conditions

1. For stable machining performance use rigid, high-precision machines and holders.
2. Use compressed air when dry machining.
3. Use wet machining for stainless steel, heat resistant alloy, and titanium alloy applications.
4. If chattering is a problem, reduce the Spindle Speed and feed rate indicated in the table below by the same ratio, or reduce the depth of cut.
5. If the machine cannot achieve the recommended spindle speed, please use the max. spindle speed available.

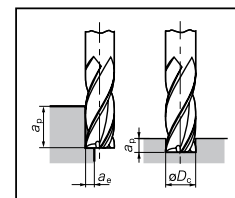

■ Shoulder Milling

Work Material	Structural Steel		Carbon Steel (150 - 250 HB)		Cast Iron		Alloy Steel (25 - 35 HRC)		Tempered Steel, Hardened Steel (35 - 45 HRC)		Hardened Steel (45 - 55 HRC)		Stainless Steel		Heat Resistant Steel Titanium Alloy	
	Spindle Speed (min ⁻¹)	Feed Rate (mm/min ⁻¹)	Spindle Speed (min ⁻¹)	Feed Rate (mm/min ⁻¹)	Spindle Speed (min ⁻¹)	Feed Rate (mm/min ⁻¹)	Spindle Speed (min ⁻¹)	Feed Rate (mm/min ⁻¹)	Spindle Speed (min ⁻¹)	Feed Rate (mm/min ⁻¹)	Spindle Speed (min ⁻¹)	Feed Rate (mm/min ⁻¹)	Spindle Speed (min ⁻¹)	Feed Rate (mm/min ⁻¹)	Spindle Speed (min ⁻¹)	Feed Rate (mm/min ⁻¹)
D _c (mm)																
1,0	21,000	360	21,000	360	21,000	360	19,000	220	13,000	140	9,000	90	10,500	90	9,000	65
2,0	10,500	360	10,500	360	10,500	360	9,600	290	7,500	180	4,500	110	5,200	120	4,500	85
4,0	5,200	500	5,200	500	5,200	500	4,800	370	4,000	280	2,250	150	2,600	160	2,250	100
6,0	3,500	560	3,500	560	3,500	560	3,200	400	2,700	300	1,500	160	1,700	170	1,500	120
8,0	2,600	520	2,600	520	2,600	520	2,400	400	2,000	300	1,100	160	1,300	170	1,100	120
10,0	2,100	500	2,100	500	2,100	500	1,900	400	1,600	300	950	160	1,000	160	900	120
12,0	1,750	500	1,750	500	1,750	500	1,600	400	1,350	300	750	150	850	160	750	120
16,0	1,300	420	1,300	420	1,300	420	1,200	330	1,000	260	550	120	650	140	550	100
20,0	1,050	380	1,050	380	1,050	380	950	290	800	230	450	110	500	120	450	90
Standard Depth of cut	a _p a _e		2,5 D _c 0,03 D _c								2,0 D _c 0,02 D _c					

n Grooving

Work Material	Structural Steel		Carbon Steel (150 - 250 HB)		Cast Iron		Alloy Steel (25 - 35 HRC)		Tempered Steel, Hardened Steel (35 - 45 HRC)		Hardened Steel (45 - 55 HRC)		Stainless Steel		Heat Resistant Steel Titanium Alloy			
	Spindle Speed (min ⁻¹)	Feed Rate (mm/min ⁻¹)	Spindle Speed (min ⁻¹)	Feed Rate (mm/min ⁻¹)	Spindle Speed (min ⁻¹)	Feed Rate (mm/min ⁻¹)	Spindle Speed (min ⁻¹)	Feed Rate (mm/min ⁻¹)	Spindle Speed (min ⁻¹)	Feed Rate (mm/min ⁻¹)	Spindle Speed (min ⁻¹)	Feed Rate (mm/min ⁻¹)	Spindle Speed (min ⁻¹)	Feed Rate (mm/min ⁻¹)	Spindle Speed (min ⁻¹)	Feed Rate (mm/min ⁻¹)		
D _c (mm)																		
1,0	16,600	140	16,600	140	16,600	140	15,500	100	10,500	100	7,500	70	9,400	60	3,750	20		
2,0	9,500	160	9,500	160	9,500	160	9,000	180	6,200	120	4,500	90	5,200	80	2,250	30		
4,0	5,200	160	5,200	180	5,200	180	4,800	160	3,400	110	2,200	65	2,600	70	1,250	25		
6,0	3,500	160	3,500	200	3,500	200	3,200	160	2,550	120	1,500	65	1,700	70	950	25		
8,0	2,600	160	2,600	200	2,600	200	2,400	160	1,900	120	1,100	65	1,300	70	700	25		
10,0	2,100	160	2,100	200	2,100	200	1,900	160	1,500	120	900	65	1,000	70	550	25		
12,0	1,750	160	1,750	200	1,750	200	1,600	160	1,250	120	750	65	850	70	450	25		
16,0	1,300	160	1,300	200	1,300	200	1,200	160	950	120	550	65	650	70	350	25		
20,0	1,050	160	1,050	200	1,050	200	950	160	750	120	450	65	500	70	280	25		
Standard Depth of cut	a _p a _e		0,1 D _c				0,2 D _c				0,05 D _c				0,1 D _c			

GSX ENDMILL

GSX 4000C-4 D

Endmill Identification (GSXMILL Series Only)

GSX 4 0100 C - 4 D

Series Code	No. of Teeth	Diameter	Cutting Edge	Cutting Edge Length
General Steel	Carbon Steel	Alloy Steel	Pre-hardened Steel	Tempered Steel, Hardened Steel
45 to 55 HRC	55 to 60 HRC	60 to 65 HRC	Stainless Steel	Ti Alloy Heat Resistant Alloy
Cast Iron	Al Alloy	Copper Alloy	Graphite	

Corner	ø Dc	Tolerance
D ≤ 3,0		0 -0,015
3,0 < D ≤ 12		0 -0,020
12,0 < D		0 -0,030

Body

(mm)

Cat. No.	Stock	ø Dc	l ₁	l ₂	L	ø Dc
GSX 40100C-4 D	•	1,0	4,0	5,0	40	4
GSX 40150C-4 D	•	1,5	6,0	7,0	40	4
GSX 40200C-4 D	•	2,0	8,0	9,0	40	4
GSX 40250C-4 D	•	2,5	10,0	11,0	50	4
GSX 40300C-4 D	•	3,0	12,0	13,5	50	6
GSX 40400C-4 D	•	4,0	16,0	17,5	50	6
GSX 40500C-4 D	•	5,0	20,0	22,0	60	6
GSX 40600C-4 D	•	6,0	24,0	—	60	6
GSX 40800C-4 D	•	8,0	32,0	—	80	8
GSX 41000C-4 D	•	10,0	40,0	—	90	10
GSX 41200C-4 D	•	12,0	48,0	—	100	12
GSX 41600C-4 D	•	16,0	64,0	—	120	16
GSX 42000C-4 D	•	20,0	80,0	—	140	20

• Euro-Stock ◦ Japan-Stock

Grade: ACF20

Recommended Cutting Conditions

1. For stable machining performance use rigid, high-precision machines and holders.
2. Use compressed air when dry machining.
3. Use wet machining for stainless steel, heat resistant alloy, and titanium alloy applications.
4. If chattering is a problem, reduce the Spindle Speed and feed rate indicated in the table below by the same ratio, or reduce the depth of cut.
5. If the machine cannot achieve the recommended spindle speed, please use the max. spindle speed available.

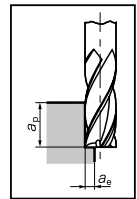

Shoulder Milling

Work Material	Structural Steel		Carbon Steel (150-250 HB)		Cast Iron		Alloy Steel (25-35 HRC)		Tempered Steel, Hardened Steel (35-45 HRC)		Hardened Steel (45-55 HRC)		Stainless Steel		Heat Resistant Steel Titanium Alloy	
	Spindle Speed (min ⁻¹)	Feed Rate (mm/min ⁻¹)	Spindle Speed (min ⁻¹)	Feed Rate (mm/min ⁻¹)	Spindle Speed (min ⁻¹)	Feed Rate (mm/min ⁻¹)	Spindle Speed (min ⁻¹)	Feed Rate (mm/min ⁻¹)	Spindle Speed (min ⁻¹)	Feed Rate (mm/min ⁻¹)	Spindle Speed (min ⁻¹)	Feed Rate (mm/min ⁻¹)	Spindle Speed (min ⁻¹)	Feed Rate (mm/min ⁻¹)	Spindle Speed (min ⁻¹)	Feed Rate (mm/min ⁻¹)
Dc (mm)																
1,0	9,000	140	9,000	140	9,000	140	7,000	80	6,500	60	4,500	40	5,400	40	4,500	40
2,0	4,500	140	4,500	140	4,500	140	3,500	100	3,200	80	2,300	55	2,700	55	2,300	40
4,0	2,250	200	2,250	200	2,250	200	1,750	120	1,600	100	1,200	60	1,350	50	1,200	35
6,0	1,500	250	1,500	250	1,500	250	1,150	160	1,050	140	800	65	900	45	800	35
8,0	1,100	220	1,100	220	1,100	220	850	160	800	130	600	65	660	45	600	35
10,0	900	210	900	210	900	210	700	140	650	120	460	65	540	45	460	35
12,0	750	200	750	200	750	200	580	140	520	110	400	65	450	45	400	35
16,0	550	170	550	170	550	170	440	120	400	95	300	55	330	45	300	35
20,0	450	150	450	150	450	150	350	100	320	80	240	50	270	45	240	35
Standard Depth of cut	ø3: 0,05 Dc		ø3 oder ø8: 0,08 Dc		ø8: 0,1 Dc		3,5 Dc		3,0 Dc		0,02 Dc					

■ Endmill Identification (GSXMILL Series Only)

GSXVL 4 020 - 2,5 D

Series Code Anti-Vibration Diameter Cutting Edge Cutting Edge Length

General Steel	Carbon Steel	Alloy Steel	Pre-hardened Steel	Tempered Steel / Die Steel	Hardened Steel	Stainless Steel	Ti Alloy / Heat Resistant Alloy	Cast Iron	Al Alloy	Copper Alloy	Graphite
•	•	•	•	•	•	•	•	•	•	•	•

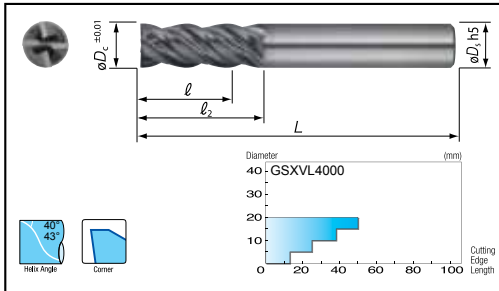

■ Body

(mm)

Cat. No.	Stock	ϕD_c	ℓ	ℓ_2	L	ϕD_s
GSXVL 4020-2,5 D	available 01/2012	2,0	5	6,5	50	4
GSXVL 4030-2,5 D	available 01/2012	3,0	8	9,5	50	6
GSXVL 4040-2,5 D	available 01/2012	4,0	10	11,5	50	6
GSXVL 4050-2,5 D	available 01/2012	5,0	13	14,5	60	6
GSXVL 4060-2,5 D	available 01/2012	6,0	15	—	60	6
GSXVL 4070-2,5 D	available 01/2012	7,0	18	20,0	70	8
GSXVL 4080-2,5 D	available 01/2012	8,0	20	—	80	8
GSXVL 4090-2,5 D	available 01/2012	9,0	23	25,0	90	10
GSXVL 4100-2,5 D	available 01/2012	10,0	25	—	90	10
GSXVL 4110-2,5 D	available 01/2012	11,0	28	30,5	90	12
GSXVL 4120-2,5 D	available 01/2012	12,0	30	—	90	12
GSXVL 4140-2,5 D	available 01/2012	14,0	35	37,5	110	16
GSXVL 4150-2,5 D	available 01/2012	15,0	38	41,0	110	16
GSXVL 4160-2,5 D	available 01/2012	16,0	40	—	115	16
GSXVL 4180-2,5 D	available 01/2012	18,0	45	48,0	120	20
GSXVL 4200-2,5 D	available 01/2012	20,0	50	—	125	20

Grade: ACF20

■ Recommended Cutting Conditions

1. For stable machining performance use rigid, high-precision machines and holders.
2. Use compressed air when dry machining.
3. Use wet machining for stainless steel, heat resistant alloy, and titanium alloy applications.
4. If chattering is a problem, reduce the Spindle Speed and feed rate indicated in the table below by the same ratio, or reduce the depth of cut.
5. If the machine cannot achieve the recommended spindle speed, please use the max. spindle speed available.

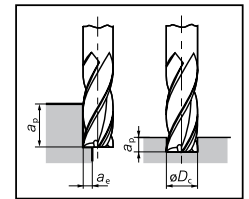

■ Shoulder Milling

Work Material	Steel (150 - 250 HB)		Alloy Steel (25 - 35 HRC)		Tempered Steel, Hardened Steel (40 - 50 HRC)		Stainless Steel		Hardened Steel (20 - 45 HRC)		
	Spindle Speed (min ⁻¹)	Feed Rate (mm/min ⁻¹)	Spindle Speed (min ⁻¹)	Feed Rate (mm/min ⁻¹)	Spindle Speed (min ⁻¹)	Feed Rate (mm/min ⁻¹)	Spindle Speed (min ⁻¹)	Feed Rate (mm/min ⁻¹)	Spindle Speed (min ⁻¹)	Feed Rate (mm/min ⁻¹)	
D _c (mm)											
2,0	9,000	720	6,000	430	4,000	320	5,500	320	2,600	120	
4,0	6,600	800	4,500	450	3,000	380	4,000	320	2,000	120	
6,0	4,800	960	3,000	480	2,500	380	3,000	480	1,200	120	
8,0	3,600	1,000	2,200	610	2,000	400	2,000	520	1,000	140	
10,0	2,800	1,000	1,800	610	1,500	400	1,700	550	800	160	
12,0	2,400	950	1,500	550	1,200	380	1,500	500	700	140	
14,0	2,200	880	1,300	490	1,000	360	1,200	430	600	130	
16,0	1,800	650	1,100	420	800	300	1,000	360	500	120	
18,0	1,600	580	1,000	360	750	270	900	340	450	110	
20,0	1,400	500	900	330	700	250	820	300	400	100	
Standard Depth of cut	a_p										
	a_e	0,1 D _c		0,05 D _c		0,1 D _c		0,05 D _c		0,2 D _c	
		1,0 D _c		0,2 D _c		0,3 D _c		0,2 D _c			

GSX Anti-Vibration ENDMILL

GSXVL 4000-R-2,5 D

Endmill Identification (GSXMILL Series Only)

GSXVL4030-R02-2,5 D

Series Code: GSXVL
 Anti-Vibration Edge: R02
 Cutting Diameter: 40
 corner radius: 2,5
 Cutting Edge Length: D

General Steel	Carbon Steel	Alloy Steel	Pre-hardened Steel	Tempered Steel, Hardened Steel	45 to 55 HRC	55 to 60 HRC	60 to 65 HRC	Stainless Steel	Ti Alloy Heat resistance Alloy	Cast Iron	Al Alloy	Copper Alloy	Graphite
---------------	--------------	-------------	--------------------	--------------------------------	--------------	--------------	--------------	-----------------	--------------------------------	-----------	----------	--------------	----------

Body

(mm)

Cat. No.	Stock	ϕD_c	r	l_1	l_2	L	ϕD_s
GSXVL 4030-R02-2,5 D	available 01/2012	3,0	0,2	8	9,5	50	6
GSXVL 4030-R05-2,5 D	available 01/2012	3,0	0,5	8	9,5	50	6
GSXVL 4040-R02-2,5 D	available 01/2012	4,0	0,2	10		50	6
GSXVL 4040-R05-2,5 D	available 01/2012	4,0	0,5	10		50	6
GSXVL 4040-R10-2,5 D	available 01/2012	4,0	1,0	10		50	6
GSXVL 4050-R02-2,5 D	available 01/2012	5,0	0,2	13		60	6
GSXVL 4050-R05-2,5 D	available 01/2012	5,0	0,5	13		60	6
GSXVL 4050-R10-2,5 D	available 01/2012	5,0	1,0	13		60	6
GSXVL 4060-R03-2,5 D	available 01/2012	6,0	0,3	15		60	6
GSXVL 4060-R05-2,5 D	available 01/2012	6,0	0,5	15		60	6
GSXVL 4060-R10-2,5 D	available 01/2012	6,0	1,0	15		60	6
GSXVL 4060-R15-2,5 D	available 01/2012	6,0	1,5	15		60	6
GSXVL 4080-R03-2,5 D	available 01/2012	8,0	0,3	20		80	8
GSXVL 4080-R05-2,5 D	available 01/2012	8,0	0,5	20		80	8
GSXVL 4080-R10-2,5 D	available 01/2012	8,0	1,0	20		80	8
GSXVL 4080-R15-2,5 D	available 01/2012	8,0	1,5	20		80	8
GSXVL 4080-R20-2,5 D	available 01/2012	8,0	2,0	20		80	8
GSXVL 4100-R03-2,5 D	available 01/2012	10,0	0,3	25		90	10
GSXVL 4100-R05-2,5 D	available 01/2012	10,0	0,5	25		90	10
GSXVL 4100-R10-2,5 D	available 01/2012	10,0	1,0	25		90	10
GSXVL 4100-R15-2,5 D	available 01/2012	10,0	1,5	25		90	10
GSXVL 4100-R20-2,5 D	available 01/2012	10,0	2,0	25		90	10
GSXVL 4120-R05-2,5 D	available 01/2012	12,0	0,5	30		90	12
GSXVL 4120-R10-2,5 D	available 01/2012	12,0	1,0	30		90	12
GSXVL 4120-R15-2,5 D	available 01/2012	12,0	1,5	30		90	12
GSXVL 4120-R20-2,5 D	available 01/2012	12,0	2,0	30		90	12
GSXVL 4120-R30-2,5 D	available 01/2012	12,0	3,0	30		90	12
GSXVL 4160-R10-2,5 D	available 01/2012	16,0	1,0	40		115	16
GSXVL 4160-R15-2,5 D	available 01/2012	16,0	1,5	40		115	16
GSXVL 4160-R20-2,5 D	available 01/2012	16,0	2,0	40		115	16
GSXVL 4160-R30-2,5 D	available 01/2012	16,0	3,0	40		115	16
GSXVL 4200-R10-2,5 D	available 01/2012	20,0	1,0	50		125	20
GSXVL 4200-R15-2,5 D	available 01/2012	20,0	1,5	50		125	20
GSXVL 4200-R20-2,5 D	available 01/2012	20,0	2,0	50		125	20
GSXVL 4200-R30-2,5 D	available 01/2012	20,0	3,0	50		125	20

Grade: ACF20

Recommended Cutting Conditions

1. For stable machining performance use rigid, high-precision machines and holders.
2. Use compressed air when dry machining.
3. Use wet machining for stainless steel, heat resistant alloy, and titanium alloy applications.
4. If chattering is a problem, reduce the Spindle Speed and feed rate indicated in the table below by the same ratio, or reduce the depth of cut.
5. If the machine cannot achieve the recommended spindle speed, please use the max. spindle speed available.

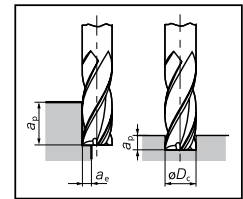

Shoulder Milling

Work Material	Steel (150 - 250 HB)		Alloy Steel (25 - 35 HRC)		Tempered Steel, Hardened Steel (40 - 50 HRC)		Stainless Steel		Hardened Steel (20 - 45 HRC)		
	Spindle Speed (min ⁻¹)	Feed Rate (mm/min ⁻¹)	Spindle Speed (min ⁻¹)	Feed Rate (mm/min ⁻¹)	Spindle Speed (min ⁻¹)	Feed Rate (mm/min ⁻¹)	Spindle Speed (min ⁻¹)	Feed Rate (mm/min ⁻¹)	Spindle Speed (min ⁻¹)	Feed Rate (mm/min ⁻¹)	
2,0	9,000	720	6,000	430	4,000	320	5,500	320	2,600	120	
4,0	6,600	800	4,500	450	3,000	380	4,000	320	2,000	120	
6,0	4,800	960	3,000	480	2,500	380	3,000	480	1,200	120	
8,0	3,600	1,000	2,200	610	2,000	400	2,000	520	1,000	140	
10,0	2,800	1,000	1,800	610	1,500	400	1,700	550	800	160	
12,0	2,400	950	1,500	550	1,200	380	1,500	500	700	140	
14,0	2,200	880	1,300	490	1,000	360	1,200	430	600	130	
16,0	1,800	650	1,100	420	800	300	1,000	360	500	120	
18,0	1,600	580	1,000	360	750	270	900	340	450	110	
20,0	1,400	500	900	330	700	250	820	300	400	100	
Standard Depth of cut	a_p			1,5 D_c							
	a_{p1}	0,1 D_c		0,05 D_c		0,1 D_c		0,05 D_c			
	a_{p2}	1,0 D_c		0,2 D_c		0,3 D_c		0,2 D_c			

D_c	r0,2	r0,3	r0,5	r1,0	r1,5	r2,0	r3,0
$\phi 3$
$\phi 4$
$\phi 5$
$\phi 6$
$\phi 8$
$\phi 10$
$\phi 12$
$\phi 16$
$\phi 20$

■ Endmill Identification (GSXMILL Series Only)

GSXB 2 0020

Series Code Ball-nose No. of Teeth Diameter

General Steel	Carbon Steel	Alloy Steel	Pre-hardened Steel	Tempered Steel	Hardened Steel	Stainless Steel	Ti Alloy	Cast Iron	Al Alloy	Copper Alloy	Graphite
•	•	•	•	•	45 to 55 HRC 55 to 60 HRC 60 to 65 HRC	•	•	•	•	•	•

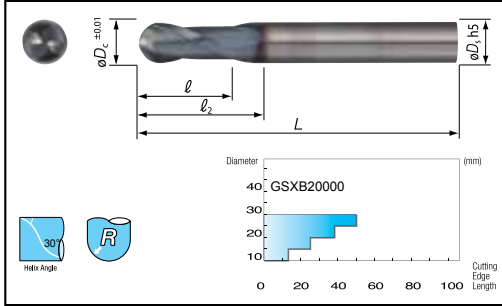

■ Body

(mm)

Cat. No.	Stock	ϕD_c	r	l_1	l_2	L	ϕD_s
GSXB 20020	available 01/2012	0,4	0,20	0,6	0,8	50	4
GSXB 20030	available 01/2012	0,6	0,30	0,9	1,2	50	4
GSXB 20050	available 01/2012	1,0	0,50	1,5	2,0	50	4
GSXB 20075	available 01/2012	1,5	0,75	2,5	3,0	50	4
GSXB 20100	available 01/2012	2,0	1,00	3,0	4,0	60	6
GSXB 20125	available 01/2012	2,5	1,25	4,0	5,0	60	6
GSXB 20150	available 01/2012	3,0	1,50	4,5	6,0	60	6
GSXB 20200	available 01/2012	4,0	2,00	6,0	8,0	70	6
GSXB 20250	available 01/2012	5,0	2,50	7,5	10,0	80	6
GSXB 20300	available 01/2012	6,0	3,00	9,0	-	80	6
GSXB 20350	available 01/2012	7,0	3,50	11,0	20,0	90	8
GSXB 20400	available 01/2012	8,0	4,00	12,0	-	90	8
GSXB 20500	available 01/2012	10,0	5,00	15,0	-	100	10
GSXB 20600	available 01/2012	12,0	6,00	18,0	-	110	12
GSXB 20700	available 01/2012	14,0	7,00	21,0	38,0	110	16
GSXB 20800	available 01/2012	16,0	8,00	24,0	-	140	16
GSXB 20900	available 01/2012	18,0	9,00	27,0	50,0	140	20
GSXB 21000	available 01/2012	20,0	10,00	30,0	-	160	20
GSXB 21250	available 01/2012	25,0	12,50	38,0	-	180	25
GSXB 21500	available 01/2012	30,0	15,00	45,0	-	180	32

Grade: ACF20

■ Recommended Cutting Conditions

1. For stable machining performance use rigid, high-precision machines and holders.
2. Use compressed air when dry machining.
3. Use wet machining for stainless steel, heat resistant alloy, and titanium alloy applications.
4. If chattering is a problem, reduce the Spindle Speed and feed rate indicated in the table below by the same ratio, or reduce the depth of cut.
5. If the machine cannot achieve the recommended spindle speed, please use the max. spindle speed available.

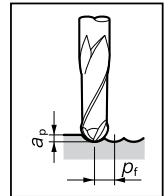

■ Free Formed Surface Milling

Work Material	Steel (150-250 HB)		Alloy Steel (25-35 HRC)		Tempered Steel, Hardened Steel (40-50 HRC)		Stainless Steel	
	Spindle Speed (min ⁻¹)	Feed Rate (mm/min ⁻¹)	Spindle Speed (min ⁻¹)	Feed Rate (mm/min ⁻¹)	Spindle Speed (min ⁻¹)	Feed Rate (mm/min ⁻¹)	Spindle Speed (min ⁻¹)	Feed Rate (mm/min ⁻¹)
R (mm)								
0,20	50,000	2,100	35,000	1,150	50,000	2,100	50,000	1,750
0,30	50,000	2,500	35,000	1,350	50,000	2,500	50,000	2,100
0,50	50,000	3,000	35,000	1,600	50,000	3,000	50,000	2,500
0,75	35,000	3,000	24,000	1,650	35,000	3,200	34,000	2,500
1,00	27,500	3,000	19,000	1,700	35,000	3,900	26,000	2,500
1,25	22,500	3,000	15,500	1,700	28,000	3,900	21,000	2,500
1,50	19,000	3,000	13,000	1,700	24,000	3,900	17,500	2,500
2,00	17,000	3,800	12,000	2,100	20,000	4,100	15,000	2,700
2,50	15,500	4,300	11,000	2,200	18,000	4,600	12,000	2,500
3,00	14,000	4,700	10,500	2,500	16,500	5,300	10,500	2,500
3,50	12,500	4,200	9,000	2,100	14,000	4,500	9,000	2,200
4,00	11,000	3,500	7,900	1,900	12,500	4,000	7,800	1,900
5,00	9,000	2,800	6,300	1,500	10,500	3,300	6,300	1,500
6,00	7,500	2,400	5,200	1,250	8,700	2,800	5,200	1,250
7,00	6,400	2,100	4,500	1,100	7,400	2,400	4,500	1,100
8,00	5,600	1,800	3,900	950	6,500	2,100	3,900	950
9,00	5,000	1,600	3,500	850	5,800	1,900	3,500	850
10,00	4,500	1,450	3,100	750	5,200	1,700	3,150	750
12,50	3,600	1,150	2,500	600	4,200	1,350	2,500	600
15,00	3,000	960	2,100	500	3,500	1,150	2,100	500
Standard Depth of cut	a_p	0,2 D _c 0,5 D _c	0,2 D _c 0,5 D _c	0,2 D _c 0,5 D _c	0,02 D _c 0,05 D _c	0,02 D _c 0,05 D _c	0,02 D _c 0,05 D _c	0,02 D _c 0,05 D _c

New "Global Standard" Solid Endmill

GSX MILL Series

■ GSX20000C



Cutting Conditions

Diameter: 6 mm
 Work Material: S50C (C25)
 V_c : 87 m/min (n=4615 rev/min)
 V_f : 553 mm/min (fz: 0,06 mm/t)
 a_p : 3 mm
 Coolant: dry
 Spindle: BT50

■ GSX20000C



Cutting Conditions

Diameter: 10 mm
 Work Material: GGG60
 V_c : 66 m/min (n=2100 rev/min)
 V_f : 302 mm/min (fz: 0,072 mm/t)
 a_p : 5 mm x5
 a_e : 10 mm
 Coolant: dry
 Spindle: BT40

■ GSX20000C

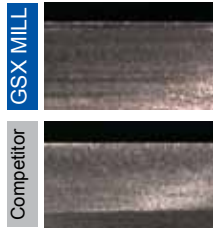

Cutting Conditions

Diameter: 10 mm
 Work Material: X5 CrNi 18-10
 V_c : 50 m/min (n=1597 rev/min)
 V_f : 127 mm/min (fz: 0,04 mm/t)
 a_p : 10 mm
 a_e : 0,3 mm
 Coolant: dry
 Spindle: BT50

■ GSX20000S

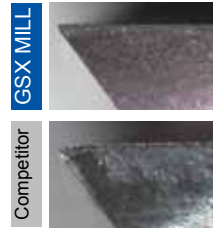

Cutting Conditions

Diameter: 6 mm
 Work Material: C50
 V_c : 87 m/min (n=4615 rev/min)
 V_f : 553 mm/min (fz: 0,06 mm/t)
 a_p : 10 mm
 a_e : 0,3 mm
 Coolant: dry
 Spindle: BT50

■ GSXB20000



Cutting Conditions

Work Material: SKD61 (1.2344) 50HRc)
 V_c : 179 m/min (n=9.500 rev/min)
 V_f : 2250 mm/min (fz: 0,11 mm/t)
 a_p : 0,2-1,0 mm
 p_r : 0,3 mm
 Coolant: emulsion
 Spindle: BT40

■ GSXVL40000

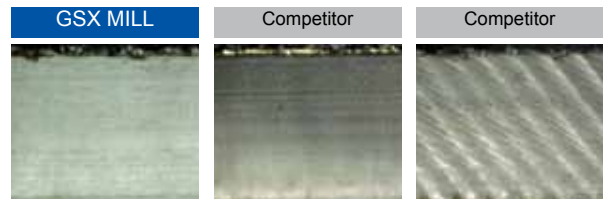

Cutting Conditions

Diameter: 10 mm
 Work Material: C50
 V_c : 150 m/min (n=4800 rev/min)
 V_f : 800 mm/min (fz: 0,042 mm/t)
 a_p : 10 mm
 Spindel: BT40



CARBIDE - CBN - DIAMOND

GERMANY

SUMITOMO ELECTRIC Hartmetall GmbH
 Siemensring 84, D-47877 Willich
 Tel. +49(0)215449920, Fax +49(0)215441072
 e-Mail: info@SumitomoTool.com
 Internet: www.SumitomoTool.com



UK AND IRELAND

SUMITOMO ELECTRIC Hardmetal Ltd.
 Summerleys Road, Princes Risborough
 Buckinghamshire HP 27 9PW, UK
 Tel. +44(0)1844342081, Fax +44(0)1844342415
 e-Mail: enquiries@sumitomo-hardmetal.co.uk
 Internet: www.sumitomo-hardmetal.co.uk



Distributed by: